

CSIR 15th Dec 2019

Application No	191620012167
Candidate Name	MANTSHA ALI
Roll No.	UP0916200636
Test Date	15/12/2019
Test Time	9:30 AM - 12:30 PM
Subject	Life Sciences

Section : Part A Life Sciences

Q.1 What day of the week will it be 61 days from a Friday?

- (1) Saturday
- (2) Sunday
- (3) Friday
- (4) Wednesday

Options 1. 1

2. 2

3. 3

4. 4

Question Type : **MSQ**

Question ID : **1879801420**

Option 1 ID : **1879805677**

Option 2 ID : **1879805678**

Option 3 ID : **1879805679**

Option 4 ID : **1879805680**

Status : **Answered**

Chosen Option : **4**

Q.2 A bag contains 8 red balls, 10 blue balls, 17 green balls. What is the minimum number of balls that needs to be taken out from the bag to ensure getting at least one ball of each colour?

- (1) 19
- (2) 18
- (3) 28
- (4) 27

Options 1. 1

2. 2

3. 3

4. 4

Question Type : **MSQ**

Question ID : **1879801405**

Option 1 ID : **1879805617**

Option 2 ID : **1879805618**

Option 3 ID : **1879805619**

<https://pathfinderacademy.in/>

Option 4 ID : [1879805620](https://pathfinderacademy.in/)
Status : **Answered**
Chosen Option : 2

Q.3 Which is the curve in the figure whose points satisfy the equation $y = \text{const} \times e^x$?

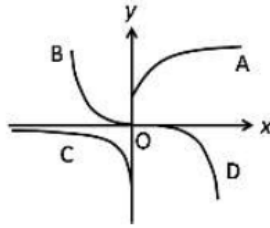

- (1) A
- (2) B
- (3) C
- (4) D

Options 1. 1
2. 2
3. 3
4. 4

Question Type : **MSQ**
Question ID : 1879801411
Option 1 ID : 1879805641
Option 2 ID : 1879805642
Option 3 ID : **1879805643**
Option 4 ID : 1879805644
Status : **Not Answered**
Chosen Option : --

Q.4 Given that $K! = 1 \times 2 \times 3 \times \dots \times K$, which is the largest among the following numbers?

- (1) $(2!)^{1/2}$
- (2) $(3!)^{1/3}$
- (3) $(4!)^{1/4}$
- (4) $\frac{(3!)}{2}$

Options 1. 1
2. 2
3. 3
4. 4

Question Type : **MSQ**
Question ID : 1879801410
Option 1 ID : 1879805637
Option 2 ID : 1879805638
Option 3 ID : 1879805639
Option 4 ID : **1879805640**
Status : **Answered**
Chosen Option : 3

Q.5 How many non-square rectangles are there in the following figure, consisting of 7 squares?

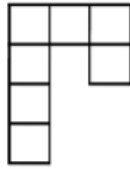

- (1) 8
- (2) 9
- (3) 10
- (4) 11

- Options**
- 1. 1
 - 2. 2
 - 3. 3
 - 4. 4

Question Type : **MSQ**
Question ID : **1879801404**
Option 1 ID : **1879805613**
Option 2 ID : **1879805614**
Option 3 ID : **1879805615**
Option 4 ID : **1879805616**
Status : **Not Answered**
Chosen Option : --

Q.6 In a college admission where applicants have to choose only one subject, $\frac{1}{4}$ th of the applicants opted for Biology, $\frac{1}{6}$ th for Chemistry, $\frac{1}{8}$ th for Physics and $\frac{1}{12}$ th for Maths. 18 applicants did not opt for any of the above four subjects. How many applicants were there?

- (1) 22
- (2) 24
- (3) 36
- (4) 48

- Options**
- 1. 1
 - 2. 2
 - 3. 3
 - 4. 4

Question Type : **MSQ**
Question ID : **1879801406**
Option 1 ID : **1879805621**
Option 2 ID : **1879805622**
Option 3 ID : **1879805623**
Option 4 ID : **1879805624**
Status : **Not Answered**
Chosen Option : --

Q.7

The mean of a set of 10 numbers is M . By combining with it a second set of M numbers, the mean of the combined set becomes 10. What is the sum of the second set of numbers?

- (1) $10M - 1$
- (2) $10M + 1$
- (3) 20
- (4) 100

Options 1. 1

- 2. 2
- 3. 3
- 4. 4

Question Type : **MSQ**

Question ID : **1879801402**

Option 1 ID : **1879805605**

Option 2 ID : **1879805606**

Option 3 ID : **1879805607**

Option 4 ID : **1879805608**

Status : **Answered**

Chosen Option : **3**

Q.8

An ice cube of volume 10 cm^3 is floating over a glass of water of 10 cm^2 cross-section area and 10 cm height. The level of the water is exactly at the brim of the glass. Given that the density of ice is 10% less than that of water, what will be the situation when ice melts completely?

- (1) The level falls by 10% of the side of the cube.
- (2) The level falls by 10% of the original height of the water column.
- (3) The level increases by 10% of the side of the cube and water spills out.
- (4) There is no change in the level of the water.

Options 1. 1

- 2. 2
- 3. 3
- 4. 4

Question Type : **MSQ**

Question ID : **1879801415**

Option 1 ID : **1879805657**

Option 2 ID : **1879805658**

Option 3 ID : **1879805659**

Option 4 ID : **1879805660**

Status : **Not Answered**

Chosen Option : **--**

Q.9

In a race five drivers were in the following situation. M was following V, R was just ahead of T, and K was the only one between T and V. Who was in the second place at that instant?

- (1) V
- (2) R
- (3) T
- (4) K

Options 1. 1

- 2. 2
- 3. 3
- 4. 4

Question Type : **MSQ**

Question ID : **1879801407**

Option 1 ID : **1879805625**

Option 2 ID : **1879805626**

Option 3 ID : **1879805627**

Option 4 ID : **1879805628**

Status : **Answered**

Chosen Option : 1

Q.10 Which of the following 7-digit numbers CANNOT be perfect squares?

$A = 45xyz26$, $B = 2xyz175$, $C = xyz3310$

- (1) Only A.
- (2) Only B.
- (3) Only C.
- (4) All three.

Options 1. 1

- 2. 2
- 3. 3
- 4. 4

Question Type : **MSQ**

Question ID : **1879801409**

Option 1 ID : **1879805633**

Option 2 ID : **1879805634**

Option 3 ID : **1879805635**

Option 4 ID : **1879805636**

Status : **Not Answered**

Chosen Option : --

Q.11

A two-digit number is such that if the digit 4 is placed to its right, its value would increase by 490. Find the original number.

- (1) 48
- (2) 54
- (3) 64
- (4) 56

Options 1. 1

- 2. 2
- 3. 3
- 4. 4

Question Type : **MSQ**

Question ID : **1879801417**

Option 1 ID : **1879805665**

Option 2 ID : **1879805666**

Option 3 ID : **1879805667**

Option 4 ID : **1879805668**

Status : **Answered**

Chosen Option : **4**

Q.12 A multiple choice exam has 4 questions, each with 4 answer choices. Every question has only one correct answer. The probability of getting all answers correct by independent random guesses for each one is

- (1) $1/4$
- (2) $(1/4)^4$
- (3) $(3/4)$
- (4) $(3/4)^4$

Options 1. 1

- 2. 2
- 3. 3
- 4. 4

Question Type : **MSQ**

Question ID : **1879801403**

Option 1 ID : **1879805609**

Option 2 ID : **1879805610**

Option 3 ID : **1879805611**

Option 4 ID : **1879805612**

Status : **Answered**

Chosen Option : **1**

Q.13 Karan's house is 20 m to the east of Rahul's house. Mehul's house is 25 m to the North-East of Rahul's house. With respect to Mehul's house in which direction is Karan's house?

- (1) East
- (2) South
- (3) North-East
- (4) West

- Options 1. 1
2. 2
3. 3
4. 4

Question Type : **MSQ**
Question ID : **1879801408**
Option 1 ID : **1879805629**
Option 2 ID : **1879805630**
Option 3 ID : **1879805631**
Option 4 ID : **1879805632**
Status : **Answered**
Chosen Option : **1**

Q.14 What is the ratio of the surface area of a cube with side 1 cm to the total surface area of the cubes formed by breaking the original cube into identical cubes of side 1 mm?

- (1) 1/6
(2) 1/10
(3) 1/100
(4) 1/36

- Options 1. 1
2. 2
3. 3
4. 4

Question Type : **MSQ**
Question ID : **1879801401**
Option 1 ID : **1879805601**
Option 2 ID : **1879805602**
Option 3 ID : **1879805603**
Option 4 ID : **1879805604**
Status : **Not Answered**
Chosen Option : **--**

Q.15 A cyclist covers a certain distance at a constant speed. If a jogger covers half the distance in double the time as the cyclist, the ratio of the speed of the jogger to that of the cyclist is

- (1) 1:4
(2) 4:1
(3) 1:2
(4) 2:1

- Options 1. 1
2. 2
3. 3
4. 4

Question Type : **MSQ**
Question ID : **1879801418**
Option 1 ID : **1879805669**
Option 2 ID : **1879805670**
Option 3 ID : **1879805671**
Option 4 ID : **1879805672**
Status : **Answered**
Chosen Option : **4**

Q.16 A four-wheeled cart is going around a circular track. Which of the following statements is correct, if the four wheels are free to rotate independent of each other, and the cart negotiates the track stably?

- (1) All wheels rotate at the same speed.
- (2) The four wheels have different speeds each.
- (3) The wheels closer to the inside of the track move slower than the outer-side wheels.
- (4) The wheels closer to the inside of the track move faster than the outer-side wheels.

- Options**
- 1. 1
 - 2. 2
 - 3. 3
 - 4. 4

Question Type : **MSQ**
 Question ID : **1879801416**
 Option 1 ID : **1879805661**
 Option 2 ID : **1879805662**
 Option 3 ID : **1879805663**
 Option 4 ID : **1879805664**
 Status : **Answered**
 Chosen Option : **3**

Q.17 Based on the bar chart shown here, which of the following inferences is correct?

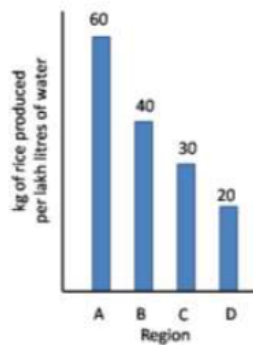

- (1) Region A uses maximum water per kg of rice.
- (2) Average water consumption of the four regions is 37.5 lakh litres.
- (3) Region D uses thrice the amount of water used by region A per kg of rice.
- (4) Region B uses 20 lakh litres of less water than region A.

- Options**
- 1. 1
 - 2. 2
 - 3. 3
 - 4. 4

Question Type : **MSQ**
 Question ID : **1879801419**
 Option 1 ID : **1879805673**
 Option 2 ID : **1879805674**
 Option 3 ID : **1879805675**
 Option 4 ID : **1879805676**
 Status : **Answered**
 Chosen Option : **3**

Q.18 In a very old, stable forest, a particular species of plants grows to a maximum height of 3 m. In a large survey, it is found that 30% of the plants have heights less than 1 m, and 50% have heights more than 2 m. From these observations we can say that the height of the plants increases

- (1) at the slowest rate when they are less than 1 m tall.
- (2) at the fastest rate when they are between 1 m and 2 m tall.
- (3) at the fastest rate when they are more than 2 m tall.
- (4) at the same rate at all stages.

Options 1. 1

2. 2
3. 3
4. 4

Question Type : **MSQ**

Question ID : **1879801413**

Option 1 ID : **1879805649**

Option 2 ID : **1879805650**

Option 3 ID : **1879805651**

Option 4 ID : **1879805652**

Status : **Not Answered**

Chosen Option : --

Q.19 Of three children, Uma plays all three of cricket, football and hockey. Iqbal plays cricket but not football, and Tarun plays hockey but neither football nor cricket. The number of games played by at least two of the children is

- (1) one.
- (2) two.
- (3) three.
- (4) zero.

Options 1. 1

2. 2
3. 3
4. 4

Question Type : **MSQ**

Question ID : **1879801412**

Option 1 ID : **1879805645**

Option 2 ID : **1879805646**

Option 3 ID : **1879805647**

Option 4 ID : **1879805648**

Status : **Answered**

Chosen Option : **3**

Q.20

The result of a survey to find the most preferred leader among A, B, C is shown in the table.

Votes	A	B	C
1 st preference	13	54	33
2 nd preference	24	37	39
3 rd preference	63	9	28

First, second and third preferences are given weights 3, 2, 1, respectively. Statistically, which of the following can be said to represent the preferences of the voters?

- (1) A and C are within 10% of each other.
- (2) B is the most preferred.
- (3) B and C are within 10% of each other.
- (4) C is the most preferred.

Options 1. 1

2. 2

3. 3

4. 4

Question Type : **MSQ**

Question ID : **1879801414**

Option 1 ID : **1879805653**

Option 2 ID : **1879805654**

Option 3 ID : **1879805655**

Option 4 ID : **1879805656**

Status : **Not Answered**

Chosen Option : --

Section : **Part B Life Sciences**

Q.1 Vascular wilts are wide spread and destructive plant diseases. The symptoms of this disease are primarily caused by the clogging of

- (1) xylem vessels
- (2) phloem vessels
- (3) stomata
- (4) hydathodes

Options 1. 1

2. 2

3. 3

4. 4

Question Type : **MSQ**

Question ID : **1879801444**

Option 1 ID : **1879805773**

Option 2 ID : **1879805774**

Option 3 ID : **1879805775**

Option 4 ID : **1879805776**

Status : **Answered**

Chosen Option : **3**

Q.2

Which one of the following statements related to transcription and processing of mRNA is **INCORRECT**?

- (1) During prokaryotic transcription, DNA binding properties of RNA polymerase are altered by sigma factor
- (2) In eukaryotic transcription, synthesis of rRNA, mRNA and some small RNAs occurs by RNA polymerases I, II and III, respectively
- (3) Splicing observed in tRNA involves successive/sequential cleavage and ligation reactions while pre-mRNA splicing proceeds through lariat formation
- (4) mRNAs with premature stop codons are degraded by Nonsense-Mediated Decay (NMD) and mRNAs without an in-frame stop codon get accumulated and translated in the cytoplasm.

Options 1. 1

2. 2

3. 3

4. 4

Question Type : **MSQ**

Question ID : **1879801429**

Option 1 ID : **1879805713**

Option 2 ID : **1879805714**

Option 3 ID : **1879805715**

Option 4 ID : **1879805716**

Status : **Not Answered**

Chosen Option : --

Q.3 Which one of the following lipid-soluble hormones can interact with a cell surface receptor?

- (1) Progesterone
- (2) Estradiol
- (3) Thyroxine
- (4) Prostaglandin

Options 1. 1

2. 2

3. 3

4. 4

Question Type : **MSQ**

Question ID : **1879801435**

Option 1 ID : **1879805737**

Option 2 ID : **1879805738**

Option 3 ID : **1879805739**

Option 4 ID : **1879805740**

Status : **Answered**

Chosen Option : **1**

Q.4

Which one of the following reactions takes place during the reduction phase of the Calvin-Benson cycle?

- (1) Ribulose 1,5-bisphosphate to 3-phosphoglycerate
- (2) 1,3-bisphosphoglycerate to glyceraldehyde-3-phosphate
- (3) Dihydroxyacetone phosphate to fructose 1,6-bisphosphate
- (4) Ribulose 5-phosphate to ribulose 1,5-bisphosphate

Options 1. 1

2. 2
3. 3
4. 4

Question Type : **MSQ**

Question ID : **1879801441**

Option 1 ID : **1879805761**

Option 2 ID : **1879805762**

Option 3 ID : **1879805763**

Option 4 ID : **1879805764**

Status : **Not Answered**

Chosen Option : --

Q.5 Two strains of mice which are genetically identical except for a single genetic locus or region are said to be:

- (1) Syngenic
- (2) Allogenic
- (3) Congenic
- (4) Heterogenic

Options 1. 1

2. 2
3. 3
4. 4

Question Type : **MSQ**

Question ID : **1879801434**

Option 1 ID : **1879805733**

Option 2 ID : **1879805734**

Option 3 ID : **1879805735**

Option 4 ID : **1879805736**

Status : **Not Answered**

Chosen Option : --

Q.6 Which one of the following was recently reported to be the first mammal to have become extinct as a result of climate change?

- (1) Bramble Cay melomys – *Melomys rubicola*
- (2) Gangetic river dolphin – *Platanista gangetica*
- (3) Malaga giant rat – *Hypogeomys antimena*
- (4) Tapanuli orangutan – *Pongo tapanuliensis*

- Options 1. 1
 2. 2
 3. 3
 4. 4

Question Type : **MSQ**
 Question ID : **1879801458**
 Option 1 ID : **1879805829**
 Option 2 ID : **1879805830**
 Option 3 ID : **1879805831**
 Option 4 ID : **1879805832**
 Status : **Answered**
 Chosen Option : **2**

Q.7 What is the probability of getting a sum of 9 from simultaneously throwing two dice?

- (1) 1/6
 (2) 1/8
 (3) 1/9
 (4) 1/12

- Options 1. 1
 2. 2
 3. 3
 4. 4

Question Type : **MSQ**
 Question ID : **1879801450**
 Option 1 ID : **1879805797**
 Option 2 ID : **1879805798**
 Option 3 ID : **1879805799**
 Option 4 ID : **1879805800**
 Status : **Answered**
 Chosen Option : **1**

Q.8 Which one of the following plants has a bisporic, 8-nucleate, bipolar embryo sac development?

- (1) *Oenothera*
 (2) *Penaea*
 (3) *Plumbago*
 (4) *Allium*

- Options 1. 1
 2. 2
 3. 3
 4. 4

Question Type : **MSQ**
 Question ID : **1879801454**
 Option 1 ID : **1879805813**
 Option 2 ID : **1879805814**
 Option 3 ID : **1879805815**
 Option 4 ID : **1879805816**
 Status : **Not Answered**
 Chosen Option : **--**

Q.9

Which one of the following is **not** a G-protein coupled receptor?

- (1) Epinephrine receptor
- (2) Transferrin receptor
- (3) Glucagon receptor
- (4) Thyroid stimulating hormone receptor

Options 1. 1

2. 2

3. 3

4. 4

Question Type : **MSQ**

Question ID : **1879801433**

Option 1 ID : **1879805729**

Option 2 ID : **1879805730**

Option 3 ID : **1879805731**

Option 4 ID : **1879805732**

Status : **Answered**

Chosen Option : **4**

Q.10

In a neuron, proteins and membranes are primarily synthesized in the cell body. These materials must be transported down the axon to the synaptic region using microtubules in an anterograde fashion. Such axonal transport is directed by

- (1) Dynein
- (2) Kinesin I
- (3) Dynein and Kinesin I
- (4) Myosin

Options 1. 1

2. 2

3. 3

4. 4

Question Type : **MSQ**

Question ID : **1879801470**

Option 1 ID : **1879805877**

Option 2 ID : **1879805878**

Option 3 ID : **1879805879**

Option 4 ID : **1879805880**

Status : **Not Answered**

Chosen Option : **--**

Q.11

The amino acid side chains of the four histones in the nucleosome are subjected to remarkable variety of post-translation modifications such as phosphorylation, acetylation and methylation. Which one of the following post-translational marks on histone tails is usually associated with transcriptional repression?

- (1) Acetylation of H3K9
- (2) Methylation of H3K9
- (3) Acetylation of H4K5
- (4) Phosphorylation of H3S10

Options 1. 1

2. 2
3. 3
4. 4

Question Type : **MSQ**

Question ID : **1879801432**

Option 1 ID : **1879805725**

Option 2 ID : **1879805726**

Option 3 ID : **1879805727**

Option 4 ID : **1879805728**

Status : **Not Answered**

Chosen Option : --

Q.12 For bacterial growth, a single cell elongates in size before it divides into two, in a process called binary fission. During cell growth,

- (1) new peptidoglycan synthesis is required along with the hydrolysis of bonds linking the old peptidoglycan chains.
- (2) new peptidoglycan synthesis is required but no hydrolysis of the old peptidoglycan occurs.
- (3) the old peptidoglycan is completely degraded and replaced with the newly synthesized longer polymer.
- (4) newly synthesized peptidoglycan is utilized to deposit a new layer of the peptidoglycan in the cell wall.

Options 1. 1

2. 2
3. 3
4. 4

Question Type : **MSQ**

Question ID : **1879801425**

Option 1 ID : **1879805697**

Option 2 ID : **1879805698**

Option 3 ID : **1879805699**

Option 4 ID : **1879805700**

Status : **Not Answered**

Chosen Option : --

Q.13

The frequency of homozygotes in a diploid population is 0.68. Assuming that the population is in Hardy-Weinberg equilibrium, the frequencies of the two alleles are

- (1) 0.1 and 0.9
- (2) 0.2 and 0.8
- (3) 0.4 and 0.6
- (4) 0.5 and 0.5

Options 1. 1

- 2. 2
- 3. 3
- 4. 4

Question Type : **MSQ**

Question ID : **1879801461**

Option 1 ID : **1879805841**

Option 2 ID : **1879805842**

Option 3 ID : **1879805843**

Option 4 ID : **1879805844**

Status : **Not Answered**

Chosen Option : --

Q.14 Which one of the following hormones is responsible for mobilizing calcium from the bone and increasing urinary excretion of phosphate?

- (1) Calcitonin
- (2) Angiotensin II
- (3) Parathormone
- (4) Vasopressin

Options 1. 1

- 2. 2
- 3. 3
- 4. 4

Question Type : **MSQ**

Question ID : **1879801448**

Option 1 ID : **1879805789**

Option 2 ID : **1879805790**

Option 3 ID : **1879805791**

Option 4 ID : **1879805792**

Status : **Answered**

Chosen Option : **2**

Q.15 Which one of the following show complete metamorphosis in all three orders?

- (1) Coleopterans, Dipterans and Hymenopterans
- (2) Coleopterans, Hymenopterans and Orthopterans
- (3) Dipterans, Lepidopterans and Hemipterans
- (4) Hymenopterans, Lepidopterans and Orthopterans

Options 1. 1

- 2. 2
- 3. 3
- 4. 4

Question Type : **MSQ**
 Question ID : **1879801455**
 Option 1 ID : **1879805817**
 Option 2 ID : **1879805818**
 Option 3 ID : **1879805819**
 Option 4 ID : **1879805820**
 Status : **Not Answered**
 Chosen Option : --

Q.16 In a lake, reducing the population of a fish which feeds on plankton was followed by a decline in the rate of primary productivity. This is consistent with which one of the following hypotheses regarding the regulation of primary productivity?

- (1) Bottom-up control
- (2) Eutrophication
- (3) Top-down control
- (4) Trophic pyramid

- Options**
- 1. 1
 - 2. 2
 - 3. 3
 - 4. 4

Question Type : **MSQ**
 Question ID : **1879801457**
 Option 1 ID : **1879805825**
 Option 2 ID : **1879805826**
 Option 3 ID : **1879805827**
 Option 4 ID : **1879805828**
 Status : **Answered**
 Chosen Option : **2**

Q.17 While screening an EMS-mutagenized population of a plant, a researcher identified a mutant with reduced gibberellic acid sensitivity. Which one of the following proteins is most likely to be defective in this mutant?

- (1) Sucrose non-fermenting related kinase 2 (SnRK2)
- (2) Constitutive triple response 1 (CTR1)
- (3) Phytochrome interacting factor (PIF)
- (4) Coronative-insensitive 1 (COI1)

- Options**
- 1. 1
 - 2. 2
 - 3. 3
 - 4. 4

Question Type : **MSQ**
 Question ID : **1879801443**
 Option 1 ID : **1879805769**
 Option 2 ID : **1879805770**
 Option 3 ID : **1879805771**
 Option 4 ID : **1879805772**
 Status : **Not Answered**

Q.18 *Agrobacterium tumefaciens* is frequently used as a vector to create transgenic plants. Under laboratory conditions *Agrobacterium* – mediated plant transformation does not require

- (1) host plant genes
- (2) bacterial type IV secretion system
- (3) *vir* genes
- (4) opine catabolism genes

- Options**
- 1. 1
 - 2. 2
 - 3. 3
 - 4. 4

Question Type : **MSQ**
 Question ID : **1879801464**
 Option 1 ID : **1879805853**
 Option 2 ID : **1879805854**
 Option 3 ID : **1879805855**
 Option 4 ID : **1879805856**
 Status : **Not Answered**
 Chosen Option : --

Q.19 Which one of the following plants has this combination of key plant traits: sporophyte dominant in the lifecycle, vascular tissue, lack of seeds?

- (1) Mosses
- (2) Ferns
- (3) Cycads
- (4) Monocots

- Options**
- 1. 1
 - 2. 2
 - 3. 3
 - 4. 4

Question Type : **MSQ**
 Question ID : **1879801453**
 Option 1 ID : **1879805809**
 Option 2 ID : **1879805810**
 Option 3 ID : **1879805811**
 Option 4 ID : **1879805812**
 Status : **Not Answered**
 Chosen Option : --

Q.20

Phosphoenol pyruvate:sugar phosphotransferase system (PTS) transports a variety of sugars into bacteria. In *E. coli*, PTS consists of EI, EII (EIIA, EIIB, and EIIC), and Hpr. During this process the sugar molecule is phosphorylated by direct transfer of phosphate group from

- (1) EI-P
- (2) EIIA-P
- (3) EIIB-P
- (4) Hpr-P

Options 1. 1

2. 2

3. 3

4. 4

Question Type : **MSQ**

Question ID : **1879801426**

Option 1 ID : **1879805701**

Option 2 ID : **1879805702**

Option 3 ID : **1879805703**

Option 4 ID : **1879805704**

Status : **Not Answered**

Chosen Option : --

Q.21

Which one of the following graphs best describes the dependence of free energy change (ΔG) of ATP hydrolysis on Mg^{2+} concentration?

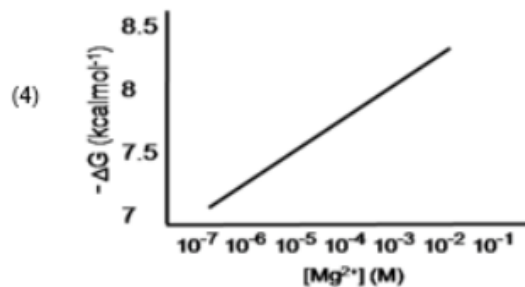
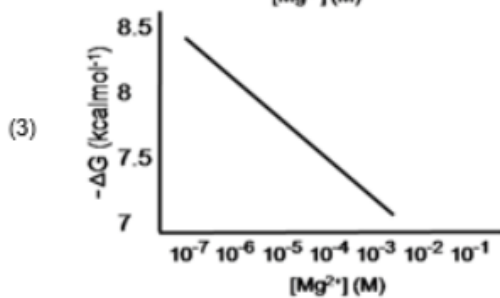
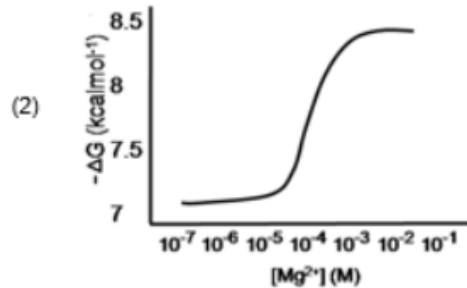
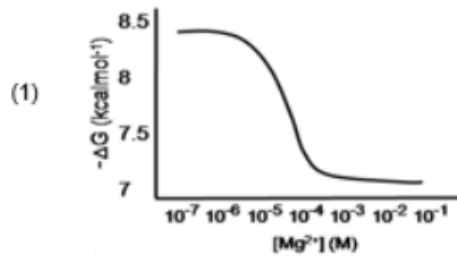

- Options 1. 1
2. 2
3. 3
4. 4

Question Type : **MSQ**

Question ID : **1879801421**

Option 1 ID : **1879805681**

Option 2 ID : **1879805682**

Option 3 ID : **1879805683**

Option 4 ID : **1879805684**

Status : **Not Answered**

Chosen Option : --

Q.22 In electron microscopy, to detect specific macromolecule or structure such as spindle pole body (SPB), the frequently used procedure is to couple secondary antibody with

- (1) Alexa 568
(2) Cy5
(3) Gold particle
(4) Osmium tetroxide

- Options
1. 1
 2. 2
 3. 3
 4. 4

Question Type : **MSQ**
 Question ID : **1879801466**
 Option 1 ID : **1879805861**
 Option 2 ID : **1879805862**
 Option 3 ID : **1879805863**
 Option 4 ID : **1879805864**
 Status : **Answered**
 Chosen Option : **3**

Q.23 Which one of the following synaptic vesicle proteins is involved in tethering of the vesicle to the cytoskeletal system in the nerve terminus?

- (1) Synaptotagmin
- (2) Synapsin
- (3) Synaptophysin
- (4) Synaptobrevin

- Options
1. 1
 2. 2
 3. 3
 4. 4

Question Type : **MSQ**
 Question ID : **1879801447**
 Option 1 ID : **1879805785**
 Option 2 ID : **1879805786**
 Option 3 ID : **1879805787**
 Option 4 ID : **1879805788**
 Status : **Not Answered**
 Chosen Option : **--**

Q.24 Interacting genes which are involved in producing continuous variation in phenotypes in a population are known as/constitute

- (1) codominant genes
- (2) pseudogenes
- (3) alleles
- (4) QTLs

- Options
1. 1
 2. 2
 3. 3
 4. 4

Question Type : **MSQ**
 Question ID : **1879801452**
 Option 1 ID : **1879805805**
 Option 2 ID : **1879805806**
 Option 3 ID : **1879805807**
 Option 4 ID : **1879805808**
 Status : **Answered**

Q.25 An interaction where the actor and the recipient both suffer a cost is referred to as

- (1) Altruism
- (2) Cooperation
- (3) Mutualism
- (4) Spite

Options 1. 1

- 2. 2
- 3. 3
- 4. 4

Question Type : **MSQ**
Question ID : **1879801460**
Option 1 ID : **1879805837**
Option 2 ID : **1879805838**
Option 3 ID : **1879805839**
Option 4 ID : **1879805840**
Status : **Answered**
Chosen Option : 2

Q.26 Centrolecithal eggs show

- (1) superficial cleavage
- (2) displaced radial cleavage
- (3) bilateral cleavage
- (4) discoidal cleavage

Options 1. 1

- 2. 2
- 3. 3
- 4. 4

Question Type : **MSQ**
Question ID : **1879801437**
Option 1 ID : **1879805745**
Option 2 ID : **1879805746**
Option 3 ID : **1879805747**
Option 4 ID : **1879805748**
Status : **Answered**
Chosen Option : 1

Q.27

The ratio of variance in male mating success (V_m) to variance in female mating success (V_f) is strongly male biased ($V_m > V_f$) in species P, strongly female biased in species Q ($V_f > V_m$) and similar in species R ($V_m = V_f$). All else being equal, which one of the following matches between species and mating systems is most likely?

- (1) P-monogamy; Q-polyandry; R-polygyny
- (2) P- polyandry; Q- polygyny; R- monogamy
- (3) P- polygyny; Q-polyandry; R- monogamy
- (4) P-monogamy; Q- polygyny; R- polyandry

Options 1. 1

2. 2

3. 3

4. 4

Question Type : **MSQ**

Question ID : **1879801459**

Option 1 ID : **1879805833**

Option 2 ID : **1879805834**

Option 3 ID : **1879805835**

Option 4 ID : **1879805836**

Status : **Not Answered**

Chosen Option : --

Q.28

The sodium-independent iodide/chloride transporter is named as

- (1) megalin
- (2) pendrin
- (3) transthyretin
- (4) prestin

Options 1. 1

2. 2

3. 3

4. 4

Question Type : **MSQ**

Question ID : **1879801446**

Option 1 ID : **1879805781**

Option 2 ID : **1879805782**

Option 3 ID : **1879805783**

Option 4 ID : **1879805784**

Status : **Answered**

Chosen Option : **2**

Q.29

Which one of the following statements is true regarding amino acids?

- (1) Proline has high propensity to form α -helix in globular proteins
- (2) Both isoleucine and threonine can exist as diastereomers
- (3) Side chain pKa of aspartic acid is more than the side chain pKa of glutamic acid
- (4) The Ψ dihedral angle of proline is more restricted than the Φ dihedral angle

Options 1. 1

2. 2
3. 3
4. 4

Question Type : **MSQ**

Question ID : **1879801422**

Option 1 ID : **1879805685**

Option 2 ID : **1879805686**

Option 3 ID : **1879805687**

Option 4 ID : **1879805688**

Status : **Answered**

Chosen Option : **3**

Q.30 Cnidarians are

- (1) triploblastic animals with bilateral symmetry.
- (2) diploblastic animals with medusa as one of the basic body forms.
- (3) monoblastic organisms with tube feet.
- (4) asymmetric organisms with tentacles containing poison glands.

Options 1. 1

2. 2
3. 3
4. 4

Question Type : **MSQ**

Question ID : **1879801456**

Option 1 ID : **1879805821**

Option 2 ID : **1879805822**

Option 3 ID : **1879805823**

Option 4 ID : **1879805824**

Status : **Not Answered**

Chosen Option : **--**

Q.31 The interaction energy between two opposite charges separated by 3\AA in vacuum is -500 kJmol^{-1} . The interaction energy between these two charges in water will be closest to

- (1) -1500 kJmol^{-1}
- (2) -166 kJmol^{-1}
- (3) -55 kJmol^{-1}
- (4) -6 kJmol^{-1}

Options 1. 1

2. 2
3. 3
4. 4

Question Type : **MSQ**
Question ID : **1879801424**
Option 1 ID : **1879805693**
Option 2 ID : **1879805694**
Option 3 ID : **1879805695**
Option 4 ID : **1879805696**
Status : **Answered**
Chosen Option : **1**

Q.32 The T-DNA region of the Ti plasmid of *Agrobacterium tumefaciens* harbours two genes: X and Y. Mutation of gene 'X' produces a rooty tumour while mutation of gene 'Y' produces shoots in the tumor. Based on the above information, which one of the following statements is correct?

- (1) Gene 'X' encodes auxins and gene 'Y' encodes cytokinins
- (2) Gene 'X' encodes cytokinins and gene 'Y' encodes auxins
- (3) Gene 'X' and gene 'Y' both encode auxins
- (4) Gene 'X' encodes opines while gene 'Y' encodes cytokinins

Options 1. 1
2. 2
3. 3
4. 4

Question Type : **MSQ**
Question ID : **1879801465**
Option 1 ID : **1879805857**
Option 2 ID : **1879805858**
Option 3 ID : **1879805859**
Option 4 ID : **1879805860**
Status : **Answered**
Chosen Option : **1**

Q.33 In context of DNA methylation, which one of the following statements is **FALSE**?

- (1) Generally, methylation occurs at the 3rd carbon position of cytosine and converts it to 3-methylcytosine
- (2) Maintenance methyltransferase acts constitutively on hemimethylated sites and converts them to fully methylated sites
- (3) During mammalian gametogenesis, the genomic methylation patterns are erased in primordial germ cells
- (4) Replication converts a fully methylated site to hemimethylated site

Options 1. 1
2. 2
3. 3
4. 4

Question Type : **MSQ**
Question ID : **1879801451**
Option 1 ID : **1879805801**
Option 2 ID : **1879805802**
Option 3 ID : **1879805803**
Option 4 ID : **1879805804**
Status : **Not Answered**
Chosen Option : **--**

Q.34 Which one of the following statements **CANNOT** be included while defining the fermentation process?

- (1) Alcohol is formed from sugar residues
- (2) Requires an electron transport system.
- (3) Utilizes an organic compound as the final electron acceptor
- (4) Produces lactic acid in oxygen deprived muscle

- Options**
- 1. 1
 - 2. 2
 - 3. 3
 - 4. 4

Question Type : **MSQ**
Question ID : **1879801462**
Option 1 ID : **1879805845**
Option 2 ID : **1879805846**
Option 3 ID : **1879805847**
Option 4 ID : **1879805848**
Status : **Answered**
Chosen Option : **4**

Q.35 If you inject a mouse with radioactive material of current activity of 256 Bq, what will be the activity after completion of 6 half-lives?

- (1) 4 Bq
- (2) 8 Bq
- (3) 16 Bq
- (4) 24 Bq

- Options**
- 1. 1
 - 2. 2
 - 3. 3
 - 4. 4

Question Type : **MSQ**
Question ID : **1879801468**
Option 1 ID : **1879805869**
Option 2 ID : **1879805870**
Option 3 ID : **1879805871**
Option 4 ID : **1879805872**
Status : **Answered**
Chosen Option : **2**

Q.36

Some statements regarding the process of autophagy are given below:

- A. Autophagy occurs when cells contain aggregated proteins
- B. Autophagosomes fuse with any organelles
- C. Autophagosome is a single membrane structure
- D. Autophagosomes fuse with lysosomes to form autophagolysosomes

Which one of the following combination of the above statements is correct?

- (1) A and B
- (2) B and C
- (3) C and D
- (4) D and A

Options 1. 1

2. 2

3. 3

4. 4

Question Type : **MSQ**

Question ID : **1879801439**

Option 1 ID : **1879805753**

Option 2 ID : **1879805754**

Option 3 ID : **1879805755**

Option 4 ID : **1879805756**

Status : **Answered**

Chosen Option : **4**

Q.37 Match the following vitamins with the corresponding pathological conditions arising from their deficiencies.

Vitamin		Disease	
(i)	A	(a)	Pernicious anaemia
(ii)	B ₁₂	(b)	Subdermal haemorrhaging
(iii)	D	(c)	Night blindness
(iv)	K	(d)	Rickets

- (1) i – c; ii – a; iii – d; iv – b
- (2) i – c; ii – b; iii – d; iv – a
- (3) i – c; ii – a; iii – b; iv – d
- (4) i – d; ii – a; iii – b; iv – d

Options 1. 1

2. 2

3. 3

4. 4

Question Type : **MSQ**

Question ID : **1879801423**

Option 1 ID : **1879805689**

Option 2 ID : **1879805690**

Option 3 ID : **1879805691**

Option 4 ID : **1879805692**

Status : **Answered**

Chosen Option : **3**

Q.38 A researcher samples n individuals randomly from a population of blackbuck and identifies their sex. The number of females in the sample follows

- (1) an exponential distribution
- (2) a binomial distribution
- (3) a Poisson distribution
- (4) a normal distribution

Options 1. 1

2. 2
3. 3
4. 4

Question Type : **MSQ**

Question ID : **1879801467**

Option 1 ID : **1879805865**

Option 2 ID : **1879805866**

Option 3 ID : **1879805867**

Option 4 ID : **1879805868**

Status : **Not Answered**

Chosen Option : --

Q.39 In summer squash, white colour fruit (W) is dominant over yellow colour (w) and disc-shaped phenotype (D) is dominant over sphere-shaped phenotype (d). Determine the genotype of the parents if the cross between white, sphere crossed with white, sphere gives $\frac{3}{4}$ white, sphere and $\frac{1}{4}$ yellow, sphere.

- (1) $WWDD \times wwdd$
- (2) $Wwdd \times Wwdd$
- (3) $WwDd \times wwdd$
- (4) $wwDD \times WWdd$

Options 1. 1

2. 2
3. 3
4. 4

Question Type : **MSQ**

Question ID : **1879801449**

Option 1 ID : **1879805793**

Option 2 ID : **1879805794**

Option 3 ID : **1879805795**

Option 4 ID : **1879805796**

Status : **Not Answered**

Chosen Option : --

Q.40 Which one of the following is **NOT** true in the process of acclimatization to high altitude?

- (1) Respiratory alkalosis
- (2) Increased 2, 3-DPG in RBC
- (3) Rise in pH of cerebrospinal fluid
- (4) Increased cytochrome oxidase in tissues

- Options 1. 1
 2. 2
 3. 3
 4. 4

Question Type : **MSQ**
 Question ID : **1879801445**
 Option 1 ID : **1879805777**
 Option 2 ID : **1879805778**
 Option 3 ID : **1879805779**
 Option 4 ID : **1879805780**
 Status : **Answered**
 Chosen Option : 1

Q.41 Readers of histone modifications include:

- (1) SUN domain proteins
- (2) BAG domain proteins
- (3) PAS domain proteins
- (4) TUDOR domain proteins

- Options 1. 1
 2. 2
 3. 3
 4. 4

Question Type : **MSQ**
 Question ID : **1879801431**
 Option 1 ID : **1879805721**
 Option 2 ID : **1879805722**
 Option 3 ID : **1879805723**
 Option 4 ID : **1879805724**
 Status : **Answered**
 Chosen Option : 3

Q.42 Which one of the following parts of root is involved in perceiving gravity?

- (1) Quiescent center
- (2) Endodermis
- (3) Root cap
- (4) Elongation zone

- Options 1. 1
 2. 2
 3. 3
 4. 4

Question Type : **MSQ**
 Question ID : **1879801442**
 Option 1 ID : **1879805765**
 Option 2 ID : **1879805766**
 Option 3 ID : **1879805767**
 Option 4 ID : **1879805768**
 Status : **Not Answered**
 Chosen Option : --

Q.43

In a form of stress response, bacteria synthesize a group of proteins called stress proteins (or heat shock proteins) such as DnaK, DnaJ, GroEL, GroES, and GrpE. DnaK is an ATP binding protein, which attaches to the newly synthesized polypeptide in conjunction with DnaJ. Which one of the following statements correctly states a step in the subsequent process of protein folding?

- (1) The affinity of DnaK to the polypeptide increases upon hydrolysis of the ATP to ADP.
- (2) DnaJ is an exchange factor that replaces ADP with ATP in DnaK
- (3) ATP hydrolysis is required for the phosphorylation of DnaJ
- (4) ATP hydrolysis is required for the phosphorylation of GrpE

Options 1. 1

2. 2

3. 3

4. 4

Question Type : **MSQ**

Question ID : **1879801428**

Option 1 ID : **1879805709**

Option 2 ID : **1879805710**

Option 3 ID : **1879805711**

Option 4 ID : **1879805712**

Status : **Not Answered**

Chosen Option : --

Q.44

Which one of the following does **NOT** use RNA-sequencing?

- (1) Mapping transcription initiation sites
- (2) Long non-coding RNA profiling
- (3) Alternative polyadenylation profiling
- (4) Mammalian epigenome sequencing

Options 1. 1

2. 2

3. 3

4. 4

Question Type : **MSQ**

Question ID : **1879801463**

Option 1 ID : **1879805849**

Option 2 ID : **1879805850**

Option 3 ID : **1879805851**

Option 4 ID : **1879805852**

Status : **Answered**

Chosen Option : **4**

Q.45

The cells of inner cell mass of a blastocyst stage mammalian embryo are

- (1) totipotent
- (2) pluripotent
- (3) multipotent
- (4) unipotent

Options 1. 1

- 2. 2
- 3. 3
- 4. 4

Question Type : **MSQ**

Question ID : **1879801438**

Option 1 ID : **1879805749**

Option 2 ID : **1879805750**

Option 3 ID : **1879805751**

Option 4 ID : **1879805752**

Status : **Answered**

Chosen Option : **1**

Q.46 Which one of the following regulatory proteins can act as a positive and negative regulator on binding to the same DNA elements?

- (1) Lac repressor (LacI)
- (2) Lambda (cI) repressor
- (3) Ara C protein (AraC)
- (4) Trp repressor (TrpR)

Options 1. 1

- 2. 2
- 3. 3
- 4. 4

Question Type : **MSQ**

Question ID : **1879801430**

Option 1 ID : **1879805717**

Option 2 ID : **1879805718**

Option 3 ID : **1879805719**

Option 4 ID : **1879805720**

Status : **Answered**

Chosen Option : **1**

Q.47

In what respect does the genome of slow-acting retroviruses differ from those of transducing viruses?

- (1) They cannot activate nearby cellular proto-oncogenes after integration into the genome of the host cell
- (2) They lack an oncogene
- (3) They exclude mouse mammary tumor viruses
- (4) They have acquired mutations during acquisition of an oncogene

Options 1. 1

2. 2

3. 3

4. 4

Question Type : **MSQ**

Question ID : **1879801436**

Option 1 ID : **1879805741**

Option 2 ID : **1879805742**

Option 3 ID : **1879805743**

Option 4 ID : **1879805744**

Status : **Not Answered**

Chosen Option : --

Q.48 Which of the following factors is known to be involved in postponing programmed cell death in cereal aleurone until endosperm mobilization is complete?

- (1) Gibberellic acid
- (2) Abscisic acid
- (3) Acidic pH of the vacuoles
- (4) cGMP mediated signal transduction pathway

Options 1. 1

2. 2

3. 3

4. 4

Question Type : **MSQ**

Question ID : **1879801440**

Option 1 ID : **1879805757**

Option 2 ID : **1879805758**

Option 3 ID : **1879805759**

Option 4 ID : **1879805760**

Status : **Not Answered**

Chosen Option : --

Q.49

Which one of the following statements related to molecular cloning procedures is **INCORRECT**?

- (1) 5' overhangs of restricted DNA fragments can be blunt-ended by Klenow polymerase but not by DNaseI.
- (2) A DNA fragment obtained as an XhoI fragment (C↓TCGAG) may be ligated at the SalI site (G↓TCGAC) in a vector.
- (3) To prevent self-ligation of a vector digested with KpnI (GGTAC↓C), alkaline phosphatase enzyme is used to remove 3'-PO₄ groups from the ends of fragments.
- (4) α-complementation/blue-white screening may produce blue coloured recombinant colonies (containing cloned fragments) in case of translational fusion with the β-galactosidase gene.

Options 1. 1

2. 2
3. 3
4. 4

Question Type : **MSQ**

Question ID : **1879801469**

Option 1 ID : **1879805873**

Option 2 ID : **1879805874**

Option 3 ID : **1879805875**

Option 4 ID : **1879805876**

Status : **Not Answered**

Chosen Option : --

Q.50 During the exponential phase of growth, if N_0 , N_t , and n define the initial population number, population number at time t , and the number of generations in time t , respectively, then

- (1) $N_t = N_0 \times 2n$
- (2) $N_0 = N_t / 2$
- (3) $N_t / N_0 = 2^n$
- (4) $N_0 / N_t = 2^n$

Options 1. 1

2. 2
3. 3
4. 4

Question Type : **MSQ**

Question ID : **1879801427**

Option 1 ID : **1879805705**

Option 2 ID : **1879805706**

Option 3 ID : **1879805707**

Option 4 ID : **1879805708**

Status : **Not Answered**

Chosen Option : --

Section : **Part C Life Sciences**

Q.1

The nucleosome is the fundamental subunit of chromatin in eukaryotes. Following statements are made about nucleosome:

- A. Generally, a typical nucleosome contains ~200bp of DNA and two copies of each histone (H2A, H2B, H3 and H4)
- B. 146 bp length of DNA per nucleosome core particle is strictly maintained across the organisms
- C. The histone octamers are not conserved during/after replication, however, H3₂-H4₂ tetramers are.
- D. Variants have been identified for all core histones except histone H3
- E. While wrapping around the core histones, the structure of DNA is altered at the middle of the nucleosome core particle and exhibits increased number of base pairs per turn

Which one of the following combination of statements is most appropriate?

- (1) A, C and E
- (2) A, B and D
- (3) B, D and E
- (4) A, C and D

Options 1. 1

2. 2

3. 3

4. 4

Question Type : **MSQ**

Question ID : **1879801477**

Option 1 ID : **1879805905**

Option 2 ID : **1879805906**

Option 3 ID : **1879805907**

Option 4 ID : **1879805908**

Status : **Answered**

Chosen Option : **1**

Q.2

Which one of the following graphs best represents the net CO₂ fixation of typical C₃ and C₄ plants under increasing CO₂ concentration and saturating light?

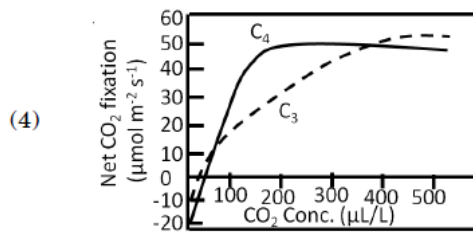
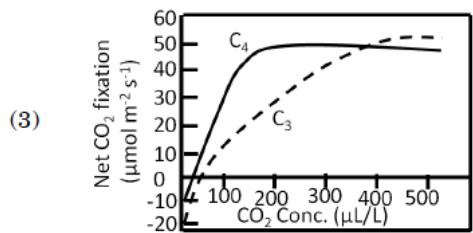
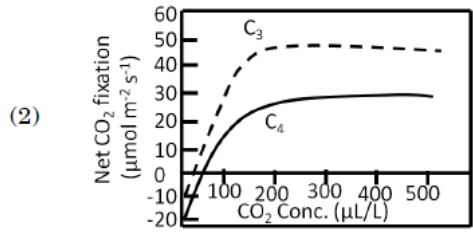
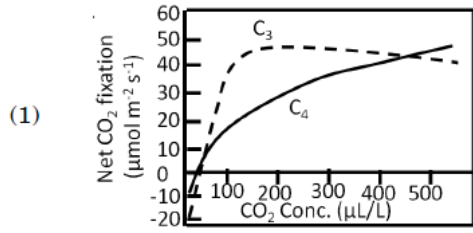

Options 1. 1

2. 2

3. 3

4. 4

Question Type : MSQ

Question ID : 1879801501

Option 1 ID : 1879806001

Option 2 ID : 1879806002

Option 3 ID : 1879806003

Option 4 ID : 1879806004

Status : Not Answered

Chosen Option : --

Q.3

The following statements are made regarding developing a transgenic mouse:

- A. The transgenic mouse thus born will be a homozygous transgenic animal and can be maintained by crossing with another transgenic animal.
- B. The fertilized transgenic eggs are allowed to develop *in vitro*.
- C. The desired gene is preferably microinjected in male pronucleus after sperm entry in oocyte.
- D. For best efficiency, the desired gene is always microinjected in the male gametes and then they are allowed to fertilize the female gametes.
- E. Blastocyst stage embryos are transferred to the uterus of hormonally prepared mother.
- F. The fertilized eggs are collected from specific strain of mouse.
- G. The female mouse of specific strain is superovulated, oocytes are collected and allowed to fertilize *in vitro*.

Choose the combination of statements arranged in the correct sequence for developing transgenic mouse.

- (1) G → C → E
- (2) F → C → B → A
- (3) G → D → A
- (4) D → F → B → A

Options 1. 1

2. 2

3. 3

4. 4

Question Type : **MSQ**

Question ID : **1879801540**

Option 1 ID : **1879806157**

Option 2 ID : **1879806158**

Option 3 ID : **1879806159**

Option 4 ID : **1879806160**

Status : **Answered**

Chosen Option : **4**

Q.4 Which of the following set of conditions will qualify a species to be considered as endangered (EN) as per IUCN criteria?

- (1) 80% reduction in population size, <100 km² area of occupancy, at least 50% estimated extinction risk in five generations.
- (2) <2,500 individuals with declining population, <250 mature individuals, at least 20% estimated extinction risk in 10 years.
- (3) <10,000 individuals with declining population, <1000 mature individuals, at least 10% estimated extinction risk in 10 years.
- (4) 75% reduction in population size, <500 km² area of occupancy, at least 20% estimated extinction risk in five generations

Options 1. 1

2. 2

3. 3

4. 4

Question Type : **MSQ**

Question ID : **1879801519**

Option 1 ID : **1879806073**

Option 2 ID : <https://pathfinderacademy.in/>
Option 3 ID : 1879806075
Option 4 ID : 1879806076
Status : Not Answered
Chosen Option : --

Q.5 Following statements were made about the post-transcriptional processing of RNA in eukaryotes.

- A. Soon after transcription initiation, RNA polymerase II pauses ~30 nucleotides downstream from the site of initiation until the Cap structure is added to the 5' end of the nascent pre-mRNA.
- B. The 5' splice sites are functionally divergent whereas the 3' sites are functionally equivalent.
- C. In addition to helping in recognition of the splice sites, the exon definition also functions as a splicing regulator by allowing pairing and linking of adjacent 5' and 3' splice sites.
- D. The intron definition mechanism applies only to the larger introns (above 500 nucleotides length) and assists in achieving alternate splicing.
- E. The splicing reactions carried out in vitro have revealed that the first and second transesterification reactions are reversible.

Which one of the following combination of statements is correct?

- (1) A, B and D
- (2) B, C and D
- (3) B, D and E
- (4) A, C and E

Options 1. 1

- 2. 2
- 3. 3
- 4. 4

Question Type : MSQ
Question ID : 1879801487
Option 1 ID : 1879805945
Option 2 ID : 1879805946
Option 3 ID : 1879805947
Option 4 ID : 1879805948
Status : Not Answered
Chosen Option : --

Q.6

Analysis of a homotetrameric protein and a double stranded DNA (that had been incubated in standard buffer) on native gels revealed that they migrated true to their physical states (tetrameric nature of the protein and double stranded nature of the DNA). Following hypotheses were made for the effect of adding high salt to the incubation mix and subsequent analysis on native gels.

- A. The protein would migrate as a homotetramer and DNA in double stranded form.
- B. The protein would migrate as a monomer but DNA in double stranded form.
- C. The protein would migrate as a homotetramer but the DNA in single stranded form.
- D. The protein would migrate as a monomer and the DNA in single stranded form.

Which of the following combination of hypotheses is most likely?

- (1) A and B
- (2) B and C
- (3) C and D
- (4) A and D

Options 1. 1

- 2. 2
- 3. 3
- 4. 4

Question Type : **MSQ**

Question ID : **1879801476**

Option 1 ID : **1879805901**

Option 2 ID : **1879805902**

Option 3 ID : **1879805903**

Option 4 ID : **1879805904**

Status : **Not Answered**

Chosen Option : --

Q.7

Given below are a few statements on use of plant breeding to develop improved varieties of a crop plant:

- A : Genotypic/phenotypic variation in the desired trait should be available in the germplasm resources of the crop plant.
- B : Availability of molecular markers linked to the trait of interest would decelerate the process of trait introgression into desired varieties.
- C : Breeding procedures to improve plant varieties are generally more successful among sexually compatible species as compared to sexually incompatible species.
- D. Co-dominant molecular markers cannot be used for selection of plants with the desired trait.

Which of the above statement(s) is/are **INCORRECT**?

- (1) A and C
- (2) B only
- (3) C and D
- (4) B and D

Options 1. 1

- 2. 2
- 3. 3
- 4. 4

Question Type : **MSQ**

Question ID : **1879801538**

Option 1 ID : <https://pathfinderacademy.in/>
 Option 2 ID : 1879806150
 Option 3 ID : 1879806151
 Option 4 ID : 1879806152
 Status : Answered
 Chosen Option : 4

Q.8 In the graph below, large boxes (denoted by P, Q, R, S) represent a region, whereas smaller boxes represent habitats. Labels S_1, S_2, \dots above each small box represent species present in the given habitat denoted by that box.

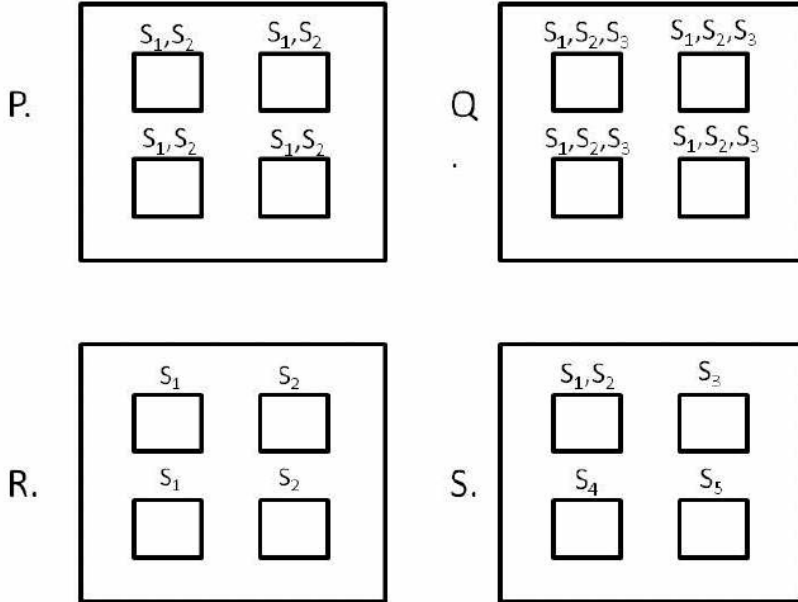

Given the above graphs, choose the option which correctly depicts the regions which show maximum α and maximum β diversity, respectively.

- (1) Q and S
- (2) P and R
- (3) S and P
- (4) Q and R

Options 1. 1
 2. 2
 3. 3
 4. 4

Question Type : MSQ
 Question ID : 1879801526
 Option 1 ID : 1879806101
 Option 2 ID : 1879806102
 Option 3 ID : 1879806103
 Option 4 ID : 1879806104
 Status : Answered
 Chosen Option : 1

Q.9

The following diagram represents a longitudinal section through an *Arabidopsis* shoot apical meristem (SAM) and leaf primordium at its flank. The dorsal (D) and ventral (V) domains are marked. The *D* and *V* genes are expressed in the dorsal and ventral domains, respectively.

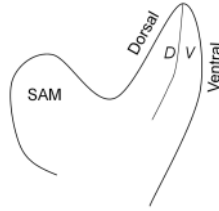

Consider the following statements describing the phenotypes of leaf polarity.

- A. Loss of *D* function makes the leaf ventralized whereas its overexpression dorsalizes the leaf.
- B. Loss of *V* function makes the leaf dorsalized whereas its overexpression ventralizes the leaf.
- C. Loss of microRNA miR166 dorsalizes the leaf whereas its overexpression ventralizes the leaf.
- D. miR166 functions by inhibiting its target mRNA.

Which one of the following functional models best describes the above results?

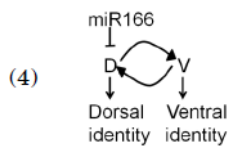
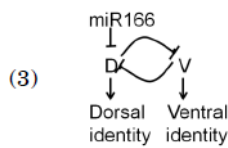
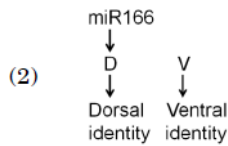
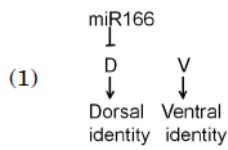

Options 1. 1

2. 2

3. 3

4. 4

Question Type : **MSQ**

Question ID : **1879801498**

Option 1 ID : **1879805989**

Option 2 ID : **1879805990**

Option 3 ID : **1879805991**

Option 4 ID : **1879805992**

Status : **Not Answered**

Chosen Option : --

Q.10

Given below are various types of molecular markers in Column A and properties of these markers in Column B.

Column A		Column B	
A.	RFLP	(i)	Single locus
B.	SSR	(ii)	Multi-allelic
C.	AFLP	(iii)	Co-dominant
D.	RAPD	(iv)	Single-allelic
		(v)	Multi-locus
		(vi)	Dominant

Which one of the options given below correctly matches the molecular markers with their properties?

- (1) A-(vi), B-(i), C-(ii), D-(v)
- (2) A-(v), B-(ii), C-(iv), D-(iii)
- (3) A-(i), B-(ii), C-(v), D-(vi)
- (4) A-(ii), B-(iii), C-(i), D-(ii)

Options 1. 1

2. 2

3. 3

4. 4

Question Type : **MSQ**

Question ID : **1879801535**

Option 1 ID : **1879806137**

Option 2 ID : **1879806138**

Option 3 ID : **1879806139**

Option 4 ID : **1879806140**

Status : **Not Answered**

Chosen Option : --

Q.11

The phylogeny below shows evolutionary relationships between 9 extant bird species and whether they display red or blue plumage.

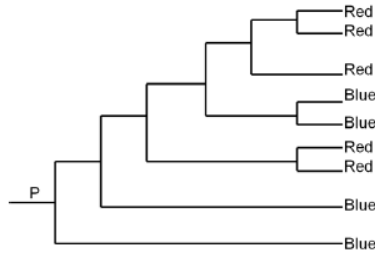

Based on the above phylogeny and the distribution of red and blue character states among the extant species, and using the principle of parsimony, which of the following is the correct inference about plumage colour of the ancestor at the root P?

- (1) Ancestral state at P is blue.
- (2) Ancestral state at P is red.
- (3) Ancestral state at P is more likely to be red than blue.
- (4) Ancestral state at P is equally likely to be red or blue.

Options 1. 1

2. 2

3. 3

4. 4

Question Type : **MSQ**

Question ID : **1879801533**

Option 1 ID : **1879806129**

Option 2 ID : **1879806130**

Option 3 ID : **1879806131**

Option 4 ID : **1879806132**

Status : **Answered**

Chosen Option : **4**

Q.12

In an organism, a^+ allele governs gray body colour, while its mutant allele a gives yellow body colour. Further, presence of b^+ allele gives long and thin hairs while b allele gives rise to short and thick hairs. The alleles a^+ and b^+ are dominant over a and b , respectively. An individual with the genotype

$$\frac{a^+ \quad b^+}{a \quad b}$$

has a patch of yellow cells with short and thick hairs. Which one of the following events is most likely to lead to the above?

- (1) Non disjunction of the homologous chromosomes during mitosis
- (2) Somatic recombination involving a and b
- (3) Translocation occurring in a few somatic cells
- (4) Mutation of both a^+ and b^+ alleles in the somatic cells

Options 1. 1

2. 2

3. 3

4. 4

Question Type : **MSQ** <https://pathfinderacademy.in/>

Question ID : **1879801512**

Option 1 ID : **1879806045**

Option 2 ID : **1879806046**

Option 3 ID : **1879806047**

Option 4 ID : **1879806048**

Status : **Not Answered**

Chosen Option : --

Q.13 A mutant mating type *mt* strain of *Chlamydomonas* that was resistant to the antibiotic kanamycin (*kan^r*) and herbicide PPT (*ppt^r*) was crossed to a wild type mating *mt⁺ kan^s ppt^s* strain that was sensitive to kanamycin and PPT. Twenty tetrads of the progeny were analyzed for mating type and resistance/sensitivity to kanamycin and PPT. The following observations were made:

	Type I	Type II	Type III
	<i>mt kan^r ppt^r</i>	<i>mt kan^r ppt^s</i>	<i>mt kan^r ppt^r</i>
	<i>mt kan^r ppt^r</i>	<i>mt kan^r ppt^s</i>	<i>mt kan^r ppt^s</i>
	<i>mt⁺ kan^r ppt^s</i>	<i>mt⁺ kan^r ppt^r</i>	<i>mt⁺ kan^r ppt^r</i>
	<i>mt⁺ kan^r ppt^s</i>	<i>mt⁺ kan^r ppt^r</i>	<i>mt⁺ kan^r ppt^s</i>
Number of each type observed	8	9	3

The following statements were made to explain the observations:

- A. *mt* and *ppt* loci are on two different chromosomes
- B. Inheritance of mating type and *ppt*-resistance/sensitivity are demonstrating cytoplasmic inheritance
- C. Inheritance of kanamycin-resistance/sensitivity is demonstrating nuclear inheritance
- D. Nuclear inheritance is being demonstrated by mating type and *ppt*-resistance/sensitivity analysis

Which one of the combinations of above statements is correct?

- (1) A and B
- (2) A and D
- (3) B and C
- (4) C and D

Options 1. 1

2. 2

3. 3

4. 4

Question Type : **MSQ**

Question ID : **1879801515**

Option 1 ID : **1879806057**

Option 2 ID : **1879806058**

Option 3 ID : **1879806059**

Option 4 ID : **1879806060**

Status : **Not Answered**

Chosen Option : --

Q.14

Several plants produce metabolites with important medicinal properties and have been extensively used in traditional medicine across the world. Many of these compounds can now be purified or synthesized and are used in modern medicine. Given below is a list of metabolites, their plant source and medicinal use:

Metabolite		Plant source		Medicine/Use	
A	Digoxin	(i)	<i>Artemisia annua</i>	Q.	Aspirin
B	Salicin	(ii)	<i>Papaver somniferum</i>	R.	Anti-malarial
C	Morphine	(iii)	<i>Digitalis purpurea</i>	S.	Cardiac ailment
D	Artemisinin	(iv)	Willow tree	T.	Narcotic analgesic

Which one of the following options is the most appropriate match of the compound with its plant source and use?

- (1) A-(iii)-R; B-(i)-T; C-(iv)-Q; D-(ii)-S
- (2) A-(iv)-Q; B-(iii)-R; C-(ii)-S; D-(i)-T
- (3) A-(ii)-T; B-(iii)-S; C-(i)-R; D-(iv)-Q
- (4) A-(iii)-S; B-(iv)-Q; C-(ii)-T; D-(i)-R

Options 1. 1

2. 2
3. 3
4. 4

Question Type : **MSQ**

Question ID : **1879801536**

Option 1 ID : **1879806141**

Option 2 ID : **1879806142**

Option 3 ID : **1879806143**

Option 4 ID : **1879806144**

Status : **Answered**

Chosen Option : **4**

Q.15 Female fiddler crabs prefer male fiddler crabs with larger claws over males with smaller claws. If the selection pressure exerted is strong resulting in a skewed distribution of claw size, which of the following statements is true about the population's mean, median and mode ?

- (1) Mean > Median > Mode
- (2) Mean < Median < Mode
- (3) Mean = Mode < Median
- (4) Mean = Median = Mode

Options 1. 1

2. 2
3. 3
4. 4

Question Type : **MSQ**

Question ID : **1879801532**

Option 1 ID : **1879806125**

Option 2 ID : **1879806126**

Option 3 ID : **1879806127**

Option 4 ID : **1879806128**

Status : **Not Answered**

Chosen Option : **--**

Q.16

The membrane phospholipid structures in bacteria and archaea differ. Which one of the following correctly states the differences between the two?

- (1) The bacterial membrane phospholipid consist of D-glycerol linked to hydrophobic chains (tails) with ester bonds whereas those of the archaeal membranes consist of L-glycerol linked to hydrophobic tails through ether bonds.
- (2) The bacterial membrane phospholipid consist of L-glycerol linked to hydrophobic chains (tails) with ester bonds whereas those of the archaeal membranes consist of D-glycerol linked to hydrophobic tails through ether bonds.
- (3) The bacterial membrane phospholipid consist of D-glycerol linked to hydrophobic chains (tails) with ether bonds whereas those of the archaeal membranes consist of L-glycerol linked to hydrophobic tails through ester bonds.
- (4) The bacterial membrane phospholipid consist of L-glycerol linked to hydrophobic chains (tails) with ether bonds whereas those of the archaeal membranes consists of D-glycerol linked to hydrophobic tails through ester bonds.

Options 1. 1

2. 2
3. 3
4. 4

Question Type : **MSQ**

Question ID : **1879801481**

Option 1 ID : **1879805921**

Option 2 ID : **1879805922**

Option 3 ID : **1879805923**

Option 4 ID : **1879805924**

Status : **Not Answered**

Chosen Option : --

Q.17

A "morphogen" can determine the fate of a cell by its concentration. Given below are some statements on the experiment performed to study the gradient-dependent effect of the morphogen, activin on cell fate by placing activin (4 nm)-secreting beads on unspecified cells from an early *Xenopus* embryo:

- A. Beads without activin did not elicit expression of either *Xbra* or *gooseoid* genes.
- B. Cells nearest to the beads getting highest concentration of activin induced *gooseoid* gene whose product is a transcription factor, specifies the frog's dorsal-most structures.
- C. Cells nearest to the beads getting highest concentration of activin induced *Xbra* gene whose product is a transcription factor, specifies the frog's dorsal-most structures.
- D. Cells farthest from the beads getting negligible activin activate *Xbra* gene and become blood vessels and heart.
- E. Cells farthest from the beads getting negligible activin, activated neither *Xbra* nor *gooseoid* and the 'default' gene expression instructed the cells to become blood vessels and heart.

Which of the above observations and conclusions drawn are correct?

- (1) A, B and C
- (2) B, C and D
- (3) C, D and E
- (4) A, B and E

Options 1. 1

2. 2
3. 3
4. 4

Question Type : **MSQ**

Question ID : **1879801496**

Option 1 ID : **1879805981**

Option 2 ID : **1879805982**

Option 3 ID : **1879805983**

Option 4 ID: 1879805984 <http://pathfinderacademy.in/>
 Status : **Not Answered**
 Chosen Option : --

Q.18 Which of the following is **NOT** a mechanism for species coexistence?

- (1) Niche differentiation
- (2) Niche complementarity
- (3) Niche overlap
- (4) Amount of limiting resources is greater than the number of species

- Options 1. 1
 2. 2
 3. 3
 4. 4

Question Type : **MSQ**
 Question ID : 1879801528
 Option 1 ID : 1879806109
 Option 2 ID : 1879806110
 Option 3 ID : 1879806111
 Option 4 ID : 1879806112
 Status : **Answered**
 Chosen Option : 4

Q.19 The top panel (graphs a-c) represents trends of number of sperms produced per mating season with respect to number of mates, while the bottom panel (graphs i-iv) represents trends of time invested in paternal care with respect to number of mates in birds.

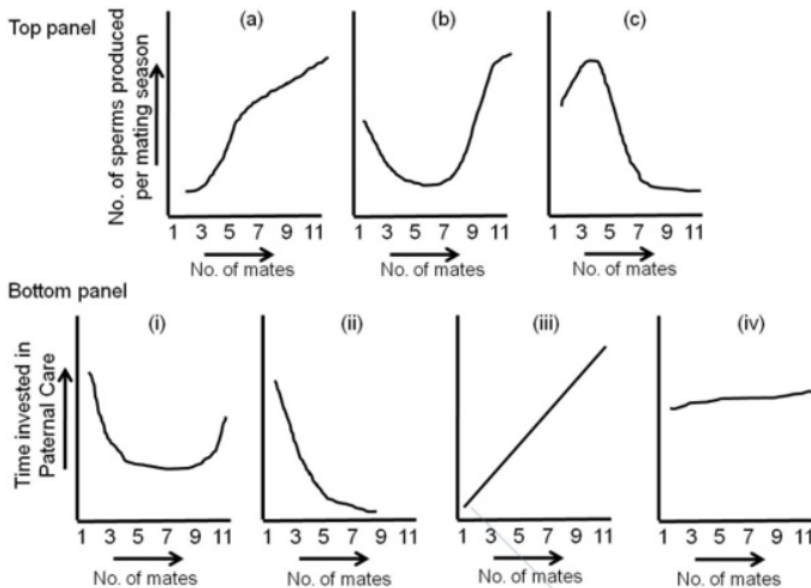

Select the correct trend from each panel.

- (1) c, iv
- (2) a, ii
- (3) b, iii
- (4) a, i

- Options 1. 1
 2. 2
 3. 3
 4. 4

Question Type : **MSQ**Question ID : **1879801534**Option 1 ID : **1879806133**Option 2 ID : **1879806134**Option 3 ID : **1879806135**Option 4 ID : **1879806136**Status : **Not Answered**

Chosen Option : --

Q.20 In an experiment, a 1 kb fragment with a single BamHI site (as shown below in figure 'A') is to be cloned in the SmaI (CCC ↓ GGG) site of a cloning vector of 3kb length (figure 'B'). None of the other enzymes of the multiple cloning site are present in the fragment to be cloned.

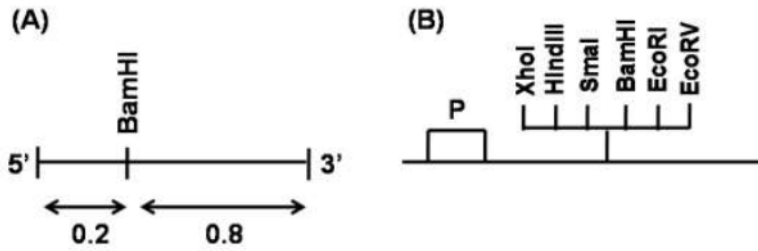

Based on the information given above, a series of digestions were set up for the potential clones and their fragment profiles are given below:

- A. BamHI : 200bp + 3.8 kb
 B. BamHI : 800bp + 3.2 kb
 C. HindIII+EcoRI : ~1kb + ~3kb
 D. XhoI+BamHI : ~200bp + ~800bp + ~3kb

Which one of the above digestion profiles confirms successful cloning of the fragment in the vector in an orientation wherein the 5' end of the cloned fragment is towards 'P'?

- (1) A only
 (2) B only
 (3) A and C
 (4) C and D

Options 1. 1

2. 2

3. 3

4. 4

Question Type : **MSQ**Question ID : **1879801543**Option 1 ID : **1879806169**Option 2 ID : **1879806170**Option 3 ID : **1879806171**Option 4 ID : **1879806172**Status : **Not Answered**

Chosen Option : --

Q.21

Thousands of proteins that are synthesized in the cytoplasm are imported into the nucleus through the nuclear pore complex (NPC) every minute. These proteins contain Nuclear Localization Signal (NLS) that direct their selective transport into the nucleus. This nuclear import requires:

- A. A small monomeric G-protein Ran.
- B. A nuclear transport receptor that interacts with the NLS on a cargo protein.
- C. A GTPase activating protein (GAP) bound to the chromatin tethered to the nuclear membrane.
- D. A Guanine Exchange Factor (GEF) bound to the chromatin inside the nucleus.

Which one of the following options represents all correct statements?

- (1) A, C, D
- (2) A, B, D
- (3) B, C only
- (4) A, C only

Options 1. 1

2. 2

3. 3

4. 4

Question Type : **MSQ**

Question ID : **1879801479**

Option 1 ID : **1879805913**

Option 2 ID : **1879805914**

Option 3 ID : **1879805915**

Option 4 ID : **1879805916**

Status : **Not Answered**

Chosen Option : --

Q.22

A pedigree shown below depicts that the individual I-1 is heterozygous for a dominant disease allele D and for molecular markers $M1/M2$. The paternal molecular markers present in the progeny individuals are indicated in the pedigree.

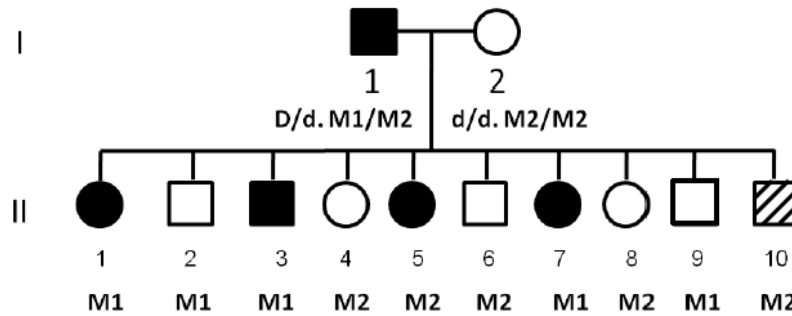

The following statements may be drawn from the above pedigree:

- The two loci D/d and $M1/M2$ appears to be linked
- The recombination frequency between the two loci is 20%
- If LOD score comes out to be 3, then it ensures that the two loci are independently assorting
- A LOD score <1 would have ensured that the two Loci are linked

Which combination of the above statements can correctly interpret the depicted pedigree?

- C and D
- Only C
- A and B
- Only D

Options 1. 1

2. 2

3. 3

4. 4

Question Type : MSQ

Question ID : 1879801516

Option 1 ID : 1879806061

Option 2 ID : 1879806062

Option 3 ID : 1879806063

Option 4 ID : 1879806064

Status : Not Answered

Chosen Option : --

Q.23

Consider the following facts:

- Chlorophyll absorbs more in the red region of the visible spectrum than in far-red.
 - The phytochrome photoreceptor (P) of plants occurs in two inter convertible forms, P_r and P_{fr} where red light converts P_r to P_{fr} and far-red light converts P_{fr} to P_r .
 - Growing a sun plant under the canopy shed causes increased stem elongation
- Which one of the following combination of statements is correct for the plants growing under the canopy as compared to those growing above the canopy?

- Red:far-red ratio is lower; $P_r:P_{fr}$ ratio is higher; P_{fr} inhibits stem elongation.
- Red: far-red ratio is higher; $P_r:P_{fr}$ ratio is higher; P_r inhibits stem elongation.
- Red: far-red ratio is lower; $P_r: P_{fr}$ ratio is lower; P_{fr} promotes stem elongation.
- Red: far-red ratio is higher; $P_r:P_{fr}$ ratio is lower; P_r promotes stem elongation.

Options 1. 1

2. 2

3.3

<https://pathfinderacademy.in/>

4.4

Question Type : **MSQ**Question ID : **1879801505**Option 1 ID : **1879806017**Option 2 ID : **1879806018**Option 3 ID : **1879806019**Option 4 ID : **1879806020**Status : **Not Answered**

Chosen Option : --

Q.24 Given below are some physicochemical properties (column X) and their manifestations (column Y).

	X		Y
A.	Pauling electronegativity	(i)	Charge separation
B.	Isolated π -orbital overlap	(ii)	Solvation of atoms
C.	Aromaticity	(iii)	Restricted rotation
D.	Dielectric constant	(iv)	Planarity of molecules

Which one of the following is the most appropriate match?

(1) A = i, B – iv, C – ii, D – iii

(2) A = iii, B – ii, C – iv, D – i

(3) A = ii, B – iii, C – iv, D – i

(4) A = iv, B – ii, C – i, D – iii

Options 1. 1

2. 2

3. 3

4. 4

Question Type : **MSQ**Question ID : **1879801473**Option 1 ID : **1879805889**Option 2 ID : **1879805890**Option 3 ID : **1879805891**Option 4 ID : **1879805892**Status : **Answered**Chosen Option : **3****Q.25**<https://pathfinderacademy.in/>

Which of the following represents exponential growth in populations?

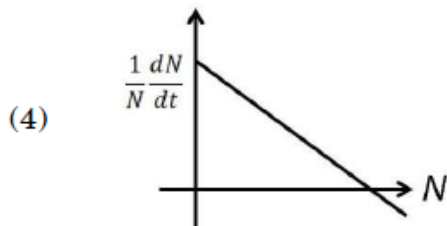
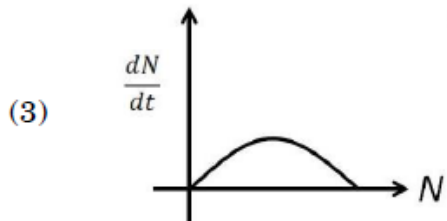
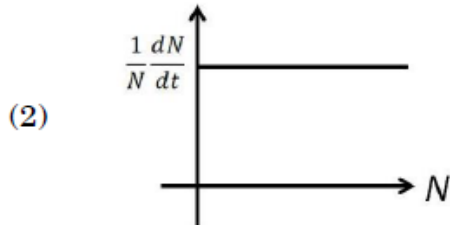
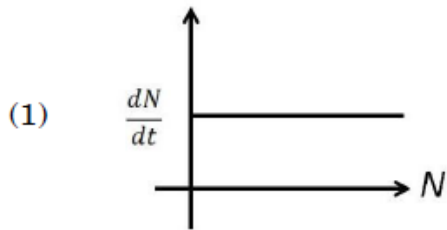

Options 1. 1

2. 2

3. 3

4. 4

Question Type : **MSQ**

Question ID : **1879801525**

Option 1 ID : **1879806097**

Option 2 ID : **1879806098**

Option 3 ID : **1879806099**

Option 4 ID : **1879806100**

Status : **Not Answered**

Chosen Option : --

Q.26

Column I	Column II	Column III
(A) Auxin and Gibberellins	(a) Transmembrane receptor	(i) Response mediated by phosphorylation/dephosphorylation
(B) Cytokinin and Brassinosteroid	(b) Soluble receptor	(ii) Response mediated by proteasome-mediated protein degradation

Match the above columns involving plant hormones and their signalling pathways:

- (1) (A) – (a) – (i) and (B) – (b) – (ii)
- (2) (A) – (b) – (ii) and (B) – (a) – (i)
- (3) (A) – (b) – (i) and (B) – (a) – (ii)
- (4) (A) – (a) – (ii) and (B) – (b) – (i)

Options 1. 1

2. 2

3. 3

4. 4

Question Type : **MSQ**

Question ID : **1879801500**

Option 1 ID : **1879805997**

Option 2 ID : **1879805998**

Option 3 ID : **1879805999**

Option 4 ID : **1879806000**

Status : **Answered**

Chosen Option : **4**

Q.27

Match the following taxa with the genus of the microorganism

Taxa		Genus	
A	Ascomycota	i	<i>Rhizopus</i>
B	Basidiomycota	ii	<i>Erysiphe</i>
C	Zygomycota	iii	<i>Pythium</i>
D	Oomycota	iv	<i>Ustilago</i>

- (1) A – ii; B – iv; C – i; D – iii
- (2) A – ii; B – iii; C – ii; D – iv
- (3) A – iii; B – iv; C – iii; D – i
- (4) A – i; B – ii; C – iv; D – ii

Options 1. 1

2. 2

3. 3

4. 4

Question Type : **MSQ**

Question ID : **1879801521**

Option 1 ID : **1879806081**

Option 2 ID : <https://pathfinderacademy.in/>
 Option 3 ID : 1879806083
 Option 4 ID : 1879806084
 Status : Answered
 Chosen Option : 4

Q.28 Given below is the [P] vs time plot of an enzymatic reaction carried out by the enzyme 'X'

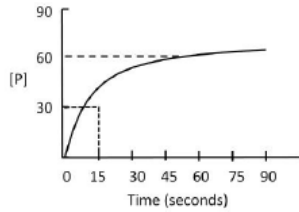

Which one of the following statements is the correct interpretation of the data?

- (1) The K_m and V_{max} of the enzyme 'X' are 15 and 60 units, respectively.
- (2) The V_{max} is 60 but the K_m cannot be determined
- (3) The K_m is 15 but the V_{max} cannot be determined
- (4) Neither the K_m nor the V_{max} of the enzyme 'X' can be determined from these data

- Options 1. 1
 2. 2
 3. 3
 4. 4

Question Type : MSQ
 Question ID : 1879801472
 Option 1 ID : 1879805885
 Option 2 ID : 1879805886
 Option 3 ID : 1879805887
 Option 4 ID : 1879805888
 Status : Not Answered
 Chosen Option : --

Q.29 A form and Z form of double stranded DNA differ in the handedness of their helices, nucleotide sequences, and configuration of base to sugar. Based on these properties, which one of the following statements defines a correct combination for A and Z forms of DNA?

- (1) Right handed double helix and *anti*-configuration for the base to sugar arrangement in A DNA; and left handed double helix with alternating sequence of G and C (as a general pattern), and alternating *syn*- and *anti*- configurations for the base to sugar arrangement in the Z DNA.
- (2) Right handed double helix and *syn*-configuration for the base to sugar arrangement in A DNA; and left handed double helix with alternating A and G sequence (as a general pattern), and *anti*-configurations for base to sugar arrangement in the Z DNA.
- (3) Left handed double helix and *anti*-configuration for base to sugar arrangement in the A form DNA and right handed double helix and *syn*-configuration for base to sugar arrangement in the Z form DNA.
- (4) Left handed double helix and *syn*-configuration for base to sugar arrangement in the A form DNA and right handed double helix and *anti*-configuration for the base to sugar arrangement for the Z form DNA.

- Options 1. 1
 2. 2
 3. 3
 4. 4

Question Type : **MSQ**Question ID : **1879801471**Option 1 ID : **1879805881**Option 2 ID : **1879805882**Option 3 ID : **1879805883**Option 4 ID : **1879805884**Status : **Answered**

Chosen Option : 1

Q.30 The figure below shows the structure of a replication fork.

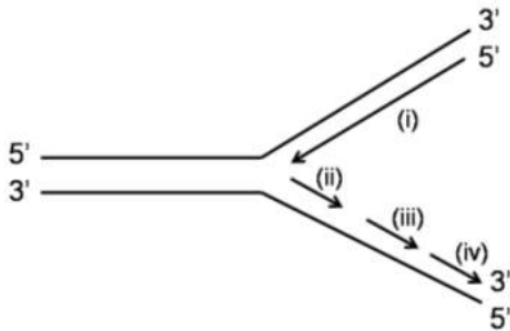

Based on this information, following statements are made:

- A. (i) represents the leading strand while (ii), (iii) and (iv) represent the Okazaki fragments.
- B. Among the Okazaki fragments, synthesis of (iv) occurs prior to the synthesis of (iii) and (ii).
- C. Among the Okazaki fragments, synthesis of (ii) occurs prior to the synthesis of (iii) and (iv).

Which one of the following options represents the correct statement(s)?

- (1) A only
- (2) B only
- (3) A and B
- (4) A and C

Options 1. 1

2. 2

3. 3

4. 4

Question Type : **MSQ**Question ID : **1879801484**Option 1 ID : **1879805933**Option 2 ID : **1879805934**Option 3 ID : **1879805935**Option 4 ID : **1879805936**Status : **Not Answered**

Chosen Option : --

Q.31

Many organisms encode only 18 aminoacyl-tRNA synthetases (aaRS). These organisms lack aaRS that use Asn or Gln (as one of the substrates) for direct aminoacylation of the tRNA^{Asn} and tRNA^{Gln}, respectively. Which one of the following statements represents the correct option?

- (1) The organisms lacking AsnRS and GlnRS lack Asn and Gln in their proteins.
- (2) In these organisms, selected Asp and Glu residues in the proteins are post-translationally modified by a regulated mechanism.
- (3) In these organisms, the tRNA^{Asn} and tRNA^{Gln} are first aminoacylated by AspRS and GluRS, respectively, and then the Asp and Glu attached to the tRNAs are modified to Asn and Gln, respectively.
- (4) In these organisms, the precursors of mRNAs that encode AspRS and GluRS are alternatively spliced to generate AsnRS and GlnRS.

- Options
- 1. 1
 - 2. 2
 - 3. 3
 - 4. 4

Question Type : **MSQ**
 Question ID : **1879801485**
 Option 1 ID : **1879805937**
 Option 2 ID : **1879805938**
 Option 3 ID : **1879805939**
 Option 4 ID : **1879805940**
 Status : **Not Answered**
 Chosen Option : --

Q.32 Individuals in a population are divided into various blood groups (in column 'X') based on the set of enzymes they have (in column 'Y'):

Column X	Column Y
A	(i) Fucose transferase
B	(ii) GalNAc transferase
AB	(iii) Gal transferase
O	

Which one of the following combinations is NOT correct for the blood group type and the set of enzymes a person has?

- (1) A - (i) and (ii)
- (2) B - (i) and (iii)
- (3) AB - (i), (ii) and (iii)
- (4) O - (i), (ii) and (iii)

- Options
- 1. 1
 - 2. 2
 - 3. 3
 - 4. 4

Question Type : **MSQ**
 Question ID : **1879801511**
 Option 1 ID : **1879806041**
 Option 2 ID : **1879806042**
 Option 3 ID : **1879806043**
 Option 4 ID : **1879806044**
 Status : **Not Answered**
 Chosen Option : --

Q.33 Absorption spectra of L-tyrosine in acidic (continuous line) and basic (dotted line) medium was estimated and plotted on a graph as depicted below:

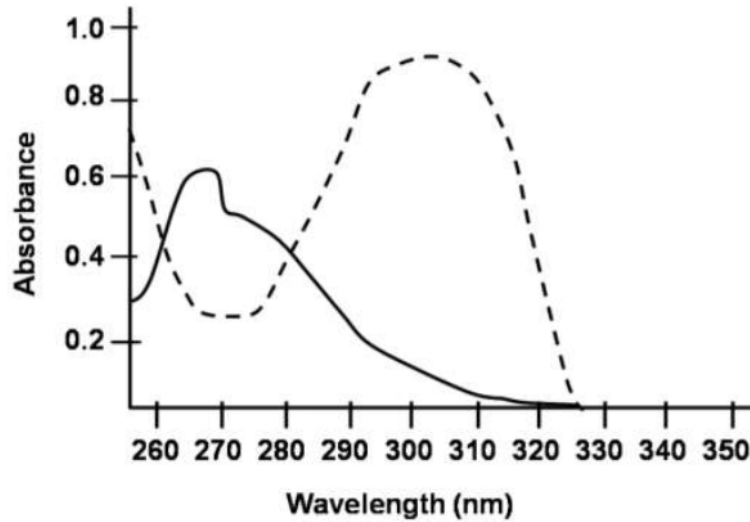

Following interpretations were made:

- A. Change in the pH from acidic to basic results in shift in the lowest energy absorption maximum and decrease in the molar absorptivity.
- B. Shifting of the absorption band to longer wavelength signifies a shift to lower energy, also known as red shift.
- C. Shifting of the absorption band to shorter wavelength signifies a shift to higher energy, also known as blue shift.
- D. Wavelength shift is always accompanied by change in intensity of the absorption band.

Select the combination with correct interpretations.

- (1) A and B
- (2) A and C
- (3) B and C
- (4) B and D

Options 1. 1

2. 2

3. 3

4. 4

Question Type : **MSQ**

Question ID : **1879801545**

Option 1 ID : **1879806177**

Option 2 ID : **1879806178**

Option 3 ID : **1879806179**

Option 4 ID : **1879806180**

Status : **Not Answered**

Chosen Option : --

Q.34

An individual is having a paracentric inversion (denoted by the region f-e-d, marked by arrows) in homozygous condition.

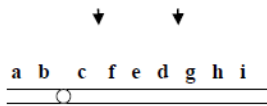

The meiotic consequences of inversion can be:

- A. generation of an acentric and a dicentric chromosome
- B. the recombinants will have long deletion or duplication and may be lethal
- C. the inversion will suppress crossing over
- D. all gametes will have complete genome and will survive normally

Which of the above statement or their combinations will explain the meiotic consequence of the given inversion logically?

- (1) A, B and C
- (2) A and B
- (3) B and C
- (4) Only D

Options 1. 1

2. 2

3. 3

4. 4

Question Type : **MSQ**

Question ID : **1879801517**

Option 1 ID : **1879806065**

Option 2 ID : **1879806066**

Option 3 ID : **1879806067**

Option 4 ID : **1879806068**

Status : **Answered**

Chosen Option : **3**

Q.35 Bacterial infections are generally divided into two broad classes: intracellular and extracellular bacterial infections. Given below are some of the properties which are applicable for bacterial infections.

- A. Humoral immune response is the main protective response against extracellular bacteria.
- B. Innate immunity is not effective against intracellular bacterial pathogens.
- C. Bacterial endotoxins do not induce an innate immune response.
- D. Intracellular bacterial infections generally induce a cell-mediated immune response resulting in secretion of cytokines which activate macrophages.

Which one of the following combination of statements is correct?

- (1) A and B
- (2) B and C
- (3) C and D
- (4) A and D

Options 1. 1

2. 2

3. 3

4. 4

Question Type : **MSQ** <https://pathfinderacademy.in/>Question ID : **1879801489**Option 1 ID : **1879805953**Option 2 ID : **1879805954**Option 3 ID : **1879805955**Option 4 ID : **1879805956**Status : **Not Answered**

Chosen Option : --

Q.36

Cells are physically linked to one another and to extracellular matrix through their cytoskeleton and this imparts strength and rigidity of tissues and organs. Most of the animal cells have three types of cytoskeletal filaments, which are listed in Column A. The possible functions are listed in Column B.

Column A	Column B
A Intermediate filaments	i Determine the shape of cell surface and are necessary for cell locomotion
B Microtubules	ii Maintain the position of membrane- enclosed organelles and provide intracellular transport
C Actin filaments	iii Provide mechanical strength of a cell

Which one is the correct match?

(1) A – i; B – ii; C – iii

(2) A – ii; B – i; C – iii

(3) A – iii; B – ii; C – i

(4) A – iii; B – i; C – ii

Options 1. 1

2. 2

3. 3

4. 4

Question Type : **MSQ**Question ID : **1879801491**Option 1 ID : **1879805961**Option 2 ID : **1879805962**Option 3 ID : **1879805963**Option 4 ID : **1879805964**Status : **Answered**Chosen Option : **2****Q.37**

Following statements are made about double-strand break repair (DSBR) model of homologous recombination:

- A. Process of DSBR recombination is triggered by introducing a double-strand break in a DNA duplex
- B. In a process known as 3'-end resection, the exonucleases along with a DNA helicase degrade one strand on either side of the break and generates 3'-single stranded termini
- C. One strand of the donor duplex is displaced due to formation of heteroduplex DNA and generates a displacement loop (D-Loop)
- D. Branch migration allows the point of crossover to move in 5' → 3' direction of recipient strand
- E. Completion of DSBR recombination may generate either crossover recombinant or non-recombinant product

Which one of the following combination of statements is correct?

- (1) A, B and D
- (2) A, C and E
- (3) A, C and D
- (4) A, B and E

Options 1. 1

2. 2

3. 3

4. 4

Question Type : **MSQ**

Question ID : **1879801518**

Option 1 ID : **1879806069**

Option 2 ID : **1879806070**

Option 3 ID : **1879806071**

Option 4 ID : **1879806072**

Status : **Not Answered**

Chosen Option : --

Q.38 In the table below Column A lists ligands and Column B lists classes of receptors

Column A	Column B
A Serotonin	i Binding activates a G-protein which activates or inhibits an enzyme that generates a specific second messenger and opens ion channel
B Interferons	ii Binding causes receptor monomers to dimerize. Dimeric receptor then interacts with and activates one or more cytosolic tyrosine protein kinases
C Glycine	iii Binding changes the conformation of the receptor so that specific ions flow through it
D Insulin	iv Binding leads to activation of intrinsic tyrosine kinase activity

Which one is the correct match?

- (1) A – i; B – ii; C – iii; D – iv
- (2) A – ii; B – iii; C – iv; D – i
- (3) A – iii; B – iv; C – i; D – ii
- (4) A – iv; B – i; C – ii; D – iii

Options 1. 1

- 2. 2
- 3. 3
- 4. 4

Question Type : **MSQ**
 Question ID : **1879801490**
 Option 1 ID : **1879805957**
 Option 2 ID : **1879805958**
 Option 3 ID : **1879805959**
 Option 4 ID : **1879805960**
 Status : **Not Answered**
 Chosen Option : --

Q.39 Following statements are being made regarding specification/determination during animal development:

A. During the course of commitment, the cell may not appear different from its nearest or most distant neighbours in the embryo and show no visible signs of differentiation; but its developmental fate is restricted.

B. At the stage of specification, cell commitment is not labile.

C. A cell or tissue is determined when it is capable of differentiating autonomously even when placed into another region of the embryo, or a cluster of differently specified cells in a petri-dish.

D. Cytoskeletal arrangements maintain positioning of nuclei in the syncytium, which enables specification of these nuclei by opposing morphogen gradients namely Bicoid and Caudal in *Drosophila*.

E. Capacity for “mosaic” development allows cells to acquire different functions as a result of interactions with neighbouring cells.

Which of the above statements are correct?

- (1) A, B and C
- (2) B, C and D
- (3) C, D and E
- (4) A, C and D

- Options**
- 1. 1
 - 2. 2
 - 3. 3
 - 4. 4

Question Type : **MSQ**
 Question ID : **1879801495**
 Option 1 ID : **1879805977**
 Option 2 ID : **1879805978**
 Option 3 ID : **1879805979**
 Option 4 ID : **1879805980**
 Status : **Not Answered**
 Chosen Option : --

Q.40

The following statements were made with the assumption that the concentration of 3-phosphoglycerate is high inside chloroplasts of an actively photosynthesizing leaf.

- A. There will be high concentration of triose phosphate in the chloroplast.
- B. The activity of ADP-glucose pyrophosphorylase will be inhibited.
- C. The carbon flow will be diverted from sucrose to starch.
- D. Starch synthesis will be inhibited and carbon flow will be more towards sucrose synthesis.

Which one of the following combinations of above statements is correct?

- (1) A and B
- (2) B and D
- (3) C and D
- (4) A and C

Options 1. 1

- 2. 2
- 3. 3
- 4. 4

Question Type : **MSQ**

Question ID : **1879801503**

Option 1 ID : **1879806009**

Option 2 ID : **1879806010**

Option 3 ID : **1879806011**

Option 4 ID : **1879806012**

Status : **Not Answered**

Chosen Option : --

Q.41 In the diagram below, the dotted line marks the point of initiation of bidirectional replication.

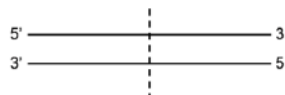

- A. On the right side of the dotted line, leading strand synthesis occurs using the upper strand as the template.
- B. On the right side of the dotted line, leading strand synthesis occurs using the lower strand as the template.
- C. A ligase deficient (lig^-) mutant would affect replication of the upper strand on the left side of the dotted line.
- D. A ligase deficient (lig^-) mutant would affect replication of the lower strand on the left side of the dotted line.

Which one of the following options represents the combinations of the correct statements?

- (1) A and D
- (2) B and C
- (3) B and D
- (4) A and C

Options 1. 1

- 2. 2
- 3. 3
- 4. 4

Question Type : **MSQ**

Question ID : **1879801488**

Option 1 ID : **1879805949**

<https://pathfinderacademy.in/>

Option 2 ID : 1879805950
 Option 3 ID : 1879805951
 Option 4 ID : 1879805952
 Status : Not Answered
 Chosen Option : --

Q.42 A mixed cell population was stained with two antibodies, one specific for cell surface antigen A and the other specific for cell surface antigen B. Anti-A antibody was labelled with fluorescein and anti-B antibody was labelled with rhodamine. The cell population was then analysed for the presence of antigens by flow cytometry. Which one of the following is the correct outcome for this cell population?

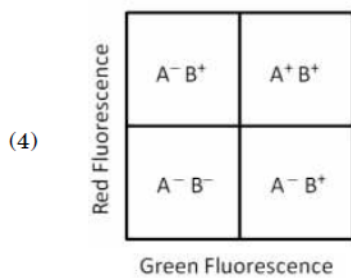
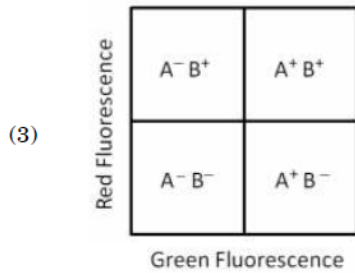
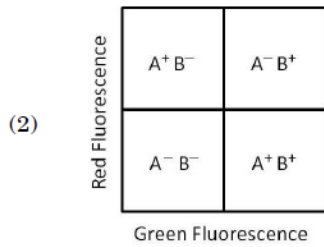
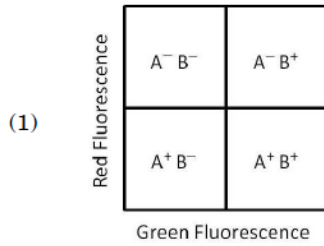

- Options 1. 1
 2. 2
 3. 3
 4. 4

Question Type : MSQ
 Question ID : 1879801539
 Option 1 ID : 1879806153
 Option 2 ID : 1879806154
 Option 3 ID : 1879806155
 Option 4 ID : 1879806156
 Status : Not Answered
 Chosen Option : --

Q.43

Given below are two sets of terms related to various methods used in biological science.

<https://pathfinderacademy.in/>

Column A		Column B	
A.	RACE	(i)	DNA-protein interactions
B.	South-Western blotting	(ii)	FAM
C.	Recursive PCR	(iii)	Determining the ends of mRNA
D.	TaqMan	(iv)	Construction of synthetic DNA

Which one of the following options correctly matches terms of Column A and Column B?

- (1) A – (iv); B – (iii); C – (i); D – (ii)
- (2) A – (iii); B – (i); C – (iv); D – (ii)
- (3) A – (ii); B – (iv); C – (i); D – (iii)
- (4) A – (ii); B – (i); C – (iv); D – (iii)

Options 1. 1

2. 2

3. 3

4. 4

Question Type : **MSQ**Question ID : **1879801542**Option 1 ID : **1879806165**Option 2 ID : **1879806166**Option 3 ID : **1879806167**Option 4 ID : **1879806168**Status : **Answered**Chosen Option : **2**

Q.44

<https://pathfinderacademy.in/>

Deletion analysis of a promoter region of a gene was carried out to identify the regulatory elements in it. In the figure below, the filled boxes denote the areas of deletion and the observed activities (in arbitrary units) of the promoter are as shown.

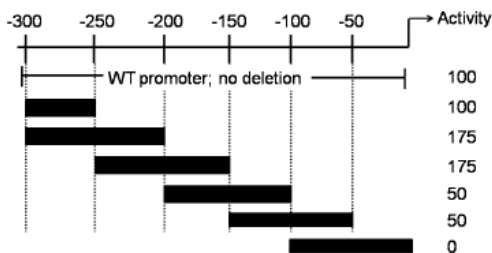

Based on the observations, following statements were made:

- A. The region between -100 and -50 houses a positive regulatory element.
- B. The region between -200 and -250 houses a negative regulatory element
- C. The region between -150 and -200 houses a positive regulatory element.

Which one of the following options represents the correct interpretation of the data?

- (1) Both A and B
- (2) A only
- (3) B only
- (4) Both B and C

Options 1. 1

2. 2

3. 3

4. 4

Question Type : **MSQ**

Question ID : **1879801482**

Option 1 ID : **1879805925**

Option 2 ID : **1879805926**

Option 3 ID : **1879805927**

Option 4 ID : **1879805928**

Status : **Not Answered**

Chosen Option : --

Q.45 During fertilization in mammals proteins Izumo and Juno are required for recognition of sperm and egg. Izumo and Juno are found specifically in sperm and egg, respectively. Which one of the following *in vivo* experiments will demonstrate that Izumo and Juno interact with each other?

- (1) If sperms from a male mouse where Izumo has been knocked out is used to fertilize eggs from a normal female and no fertilization occurs.
- (2) Whole mount immunostaining for Izumo and Juno shows its presence on the sperm and egg, respectively.
- (3) If a CFP fused Izumo protein is mixed with YFP fused Juno protein in a tube, FRET occurs, i.e., when CFP is excited, emission of YFP is observed.
- (4) Two independent kidney cell lines are developed, one expressing Izumo and the other Juno. If the two cells are mixed, they tend to aggregate with each other.

Options 1. 1

2. 2

3. 3

4. 4

Question Type : [MSQ](https://pathfinderacademy.in/)

Question ID : 1879801499

Option 1 ID : 1879805993

Option 2 ID : 1879805994

Option 3 ID : 1879805995

Option 4 ID : 1879805996

Status : Not Answered

Chosen Option : --

Q.46 Following statements were made with respect to transcription in eukaryotes:

- A. RNA polymerase III synthesises mRNAs in the nucleoplasm
- B. The target promoter for RNA polymerase III is usually represented by a bipartite sequence downstream of the transcription start site.
- C. The assembly factors TFIIIA and TFIIIC assist the binding of the positioning factor TFIIIB at the precise location.
- D. TFIIIB is the last factor that joins the initiation complex.
- E. Phosphorylated Ser residues in the C-terminal domain (CTD) of RNA polymerase II serve as binding sites for mRNA processing enzymes.

Which one of the following options represents the correct combination of the statements?

- (1) A, B and C
- (2) B, C and E
- (3) B, D and E
- (4) A, C and E

Options 1. 1

2. 2

3. 3

4. 4

Question Type : MSQ

Question ID : 1879801483

Option 1 ID : 1879805929

Option 2 ID : 1879805930

Option 3 ID : 1879805931

Option 4 ID : 1879805932

Status : Not Answered

Chosen Option : --

Q.47

Which one of the following phylogenies best represents the evolutionary relationship among whales, dolphins, seals, deer and dogs?

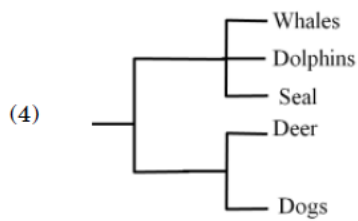
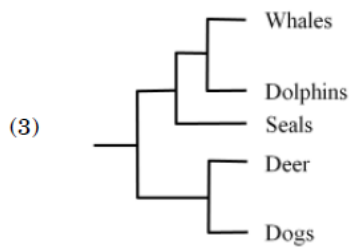
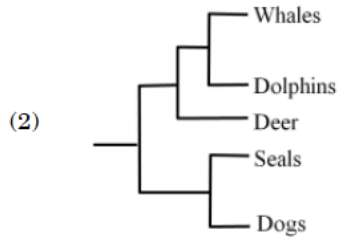
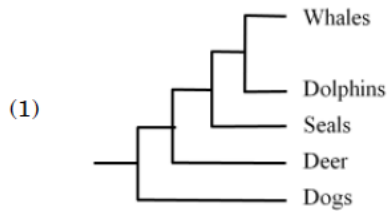

Options 1. 1

2. 2

3. 3

4. 4

Question Type : **MSQ**

Question ID : **1879801523**

Option 1 ID : **1879806089**

Option 2 ID : **1879806090**

Option 3 ID : **1879806091**

Option 4 ID : **1879806092**

Status : **Answered**

Chosen Option : **4**

Q.48

Thyroid hormone (T_3) increases the heart rate and the force of contraction of cardiac muscles. The mechanisms of these effects of T_3 have been explained by a researcher in the following statements:

- A. T_3 inhibits the expression of gene for α -myosin heavy chain and enhances the expression of gene for β -myosin heavy chain
- B. The expression of gene for Na^+-Ca^{++} antiporter is enhanced by T_3
- C. The sarcoplasmic reticulum Ca^{++} ATPase is increased by T_3
- D. T_3 increases ryanodine Ca^{++} channels in the sarcoplasmic reticulum
- E. The number of β -adrenergic receptors in heart muscles is inhibited by T_3

Which one of the following combinations contains both correct explanations?

- (1) A and B
- (2) B and C
- (3) C and D
- (4) D and E

Options 1. 1

2. 2

3. 3

4. 4

Question Type : **MSQ**

Question ID : **1879801506**

Option 1 ID : **1879806021**

Option 2 ID : **1879806022**

Option 3 ID : **1879806023**

Option 4 ID : **1879806024**

Status : **Not Answered**

Chosen Option : --

Q.49

In the following pedigree three STR loci *A*, *B* and *C* are linked on the long arm of the X-chromosome in the order centromere-A-B-C-telomere. Further in the table, the STR alleles present in each individual is indicated.

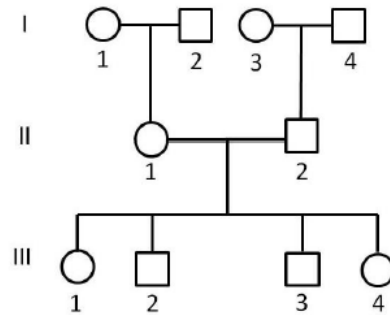

Loci	Generation									
	I				II		III			
	1	2	3	4	1	2	1	2	3	4
A	5,6	4	5,6	4	4,6	6	6	4	6	6
B	7,8	9	8,9	7	7,9	8	8,9	9	7	7,8
C	1,2	2	1,2	3	1,2	1	1,2	2	2	1

Based on the above, X-chromosome(s) in which of the following individuals are recombinant?

[Hint: X-chromosome in males will help identify the phase of the alleles]

- (1) II - 1, III - 1 and III - 2
- (2) II - 2, III - 1 and III - 2
- (3) III - 1 and III - 3
- (4) III - 2 and III - 4

Options 1. 1

2. 2

3. 3

4. 4

Question Type : **MSQ**

Question ID : **1879801514**

Option 1 ID : **1879806053**

Option 2 ID : **1879806054**

Option 3 ID : **1879806055**

Option 4 ID : **1879806056**

Status : **Not Answered**

Chosen Option : --

Q.50

Given below are schematic representations of the T-DNA regions of four constructs that are to be used for *Agrobacterium* – mediated transformation to silence an endogenous plant gene represented as 'XYFP' that is expressed constitutively in the plant.

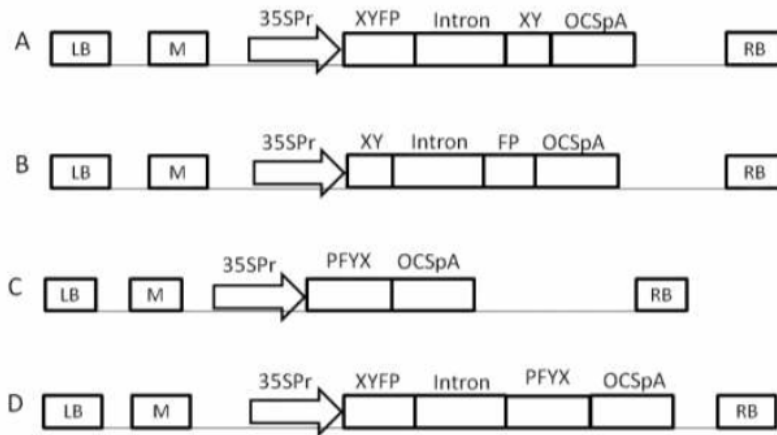

M : Selectable marker gene expression cassette
 LB : Left Border
 RB : Right Border

Which of the four constructs depicted above could be used to silence the target gene 'XYFP'?

- (1) A and B only
- (2) B and D only
- (3) A and C only
- (4) C and D only

Options 1. 1

2. 2

3. 3

4. 4

Question Type : **MSQ**

Question ID : **1879801537**

Option 1 ID : **1879806145**

Option 2 ID : **1879806146**

Option 3 ID : **1879806147**

Option 4 ID : **1879806148**

Status : **Not Answered**

Chosen Option : --

Q.51

Drawn below is an intestinal epithelial cell (IEC) performing the absorption of digested monosaccharides from the dietary carbohydrates ingested.

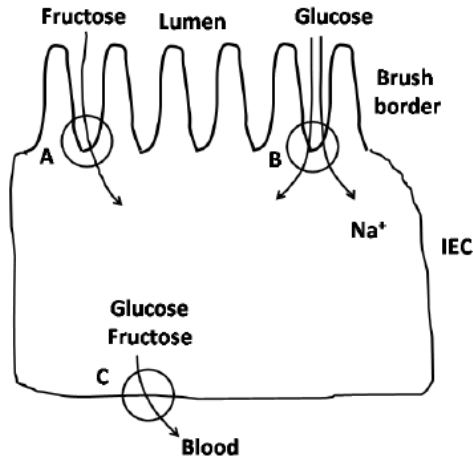

Which one of the following combinations of the transporter (A, B and C in the figure above) and the transported monosaccharide is correct?

- (1) A – GLUT5; B – SGLT1; C – GLUT2
- (2) A – GLUT2; B – GLUT5; C – SGLT1
- (3) A – SGLT1; B – GLUT2; C – GLUT5
- (4) A – SGLT1; B – GLUT5; C – GLUT2

- Options
- 1. 1
 - 2. 2
 - 3. 3
 - 4. 4

Question Type : **MSQ**
 Question ID : **1879801510**
 Option 1 ID : **1879806037**
 Option 2 ID : **1879806038**
 Option 3 ID : **1879806039**
 Option 4 ID : **1879806040**
 Status : **Not Answered**
 Chosen Option : --

Q.52 Hormones act by producing/activating a variety of effectors intracellularly. Below are given a variety of effectors in column 'X' and hormones in column 'Y'

Column X	Column Y
A Inositol triphosphate (IP ₃)	(i) Leptin
B cGMP	(ii) IGF-1
C cAMP	(iii) Oxytocin
D Receptor Kinase	(iv) Somatostatin
E Associated Kinase	(v) ANF

Which one of the following combinations of effector and the specific hormone is correct?

- (1) A (i) and B (ii)
- (2) B (iv) and A (iii)
- (3) C (iv) and D (ii)
- (4) E (ii) and C (i)

- Options 1. 1
 2. 2
 3. 3
 4. 4

Question Type : **MSQ**
 Question ID : **1879801509**
 Option 1 ID : **1879806033**
 Option 2 ID : **1879806034**
 Option 3 ID : **1879806035**
 Option 4 ID : **1879806036**
 Status : **Not Answered**
 Chosen Option : --

Q.53 The following statements are made

A. B form of DNA has ~10 base pairs/turn and A form of DNA has ~2.3Å helix rise per base pair

B. Both the A and B form of DNA have wider major groove and narrow minor groove

C. The crystalline nature of cellulose is brought about by α (1→ 4) linkage between the glucose subunits.

D. The double bonds in natural lipids are always *cis*, which provides fluidity to the plasma membrane.

Which of the following combinations represent the correct statements?

- (1) A and C
 (2) B and C
 (3) A and D
 (4) C and D

- Options 1. 1
 2. 2
 3. 3
 4. 4

Question Type : **MSQ**
 Question ID : **1879801475**
 Option 1 ID : **1879805897**
 Option 2 ID : **1879805898**
 Option 3 ID : **1879805899**
 Option 4 ID : **1879805900**
 Status : **Answered**
 Chosen Option : **1**

Q.54

The ECG recorded by different leads is analysed on the basis of variation of electrical potential at various loci on the surface of the body, and the time scale relation of different waves. After analysing the ECG, following particulars of heart are proposed to be obtained:

- A. Stoke volume and cardiac output
- B. Volume and pressure changes during cardiac cycle
- C. Anatomical orientation of heart
- D. Various disturbances in the rhythm and conduction of cardiac excitation
- E. The extent, location and progress of ischemic damage to myocardium

Which one of the following combinations represents both **INCORRECT** particulars of heart?

- (1) A and B
- (2) B and C
- (3) C and D
- (4) D and E

Options 1. 1

2. 2

3. 3

4. 4

Question Type : **MSQ**

Question ID : **1879801541**

Option 1 ID : **1879806161**

Option 2 ID : **1879806162**

Option 3 ID : **1879806163**

Option 4 ID : **1879806164**

Status : **Answered**

Chosen Option : **2**

Q.55

A small number (approximately 10) of mice are introduced into an uninhabited island. Their population grows exponentially initially and after 3 years, reaches a population size of 520 after which the population becomes stable. At what point would you expect their population to attain their highest growth rate?

- (1) When the mice population was first introduced.
- (2) When the population size is 260.
- (3) Their population growth rate remains constant throughout.
- (4) When the population size reaches 520.

Options 1. 1

2. 2

3. 3

4. 4

Question Type : **MSQ**

Question ID : **1879801529**

Option 1 ID : **1879806113**

Option 2 ID : **1879806114**

Option 3 ID : **1879806115**

Option 4 ID : **1879806116**

Status : **Not Answered**

Chosen Option : **--**

Q.56

To investigate the dynamic nature of two unrelated centrosome-localized GFP-tagged proteins [GFP-A; GFP-B], a team of scientists conducted fluorescence recovery after photo bleaching (FRAP) experiment. The FRAP profile of these two proteins is given below:

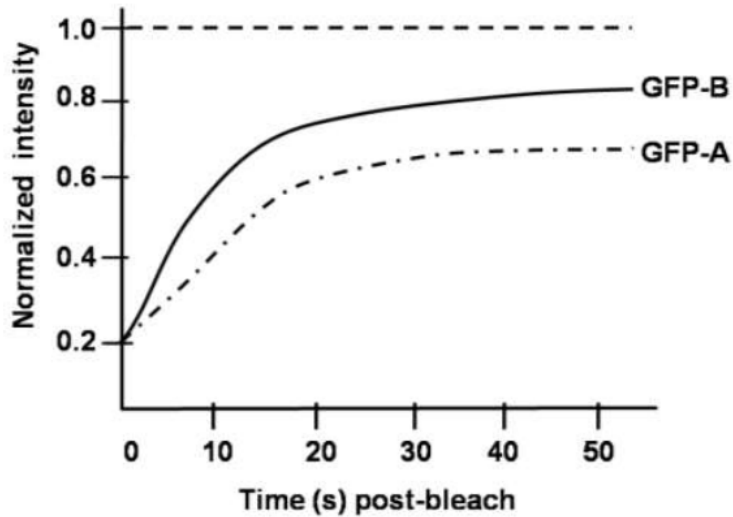

The following statements for this FRAP analysis were made

- A. GFP-B shows faster exchange rate than GFP-A
- B. GFP-A shows faster exchange rate than GFP-B
- C. GFP-A has more immobile fraction than GFP-B
- D. GFP-B has more immobile fraction than GFP-A

Which of the above mentioned statements for GFP-A and GFP-B are correct?

- (1) A and C
- (2) A and D
- (3) B and C
- (4) B and D

Options 1. 1

- 2. 2
- 3. 3
- 4. 4

Question Type : **MSQ**

Question ID : **1879801544**

Option 1 ID : **1879806173**

Option 2 ID : **1879806174**

Option 3 ID : **1879806175**

Option 4 ID : **1879806176**

Status : **Not Answered**

Chosen Option : --

Q.57

Listeria is a food-borne pathogen that causes mild gastro-intestinal symptoms. To move from one host-cell to another, it polymerizes actin into a comet tail like structure. Listeria can assemble host-cell actin at its rear end because:

- A. Listeria has on its surface a protein called Act A
- B. Listeria can activate Arp 2/3 complex
- C. Listeria has on its surface γ -tubulin
- D. Listeria has on its surface myosin II motor

Which one of the following options represents all correct statements?

- (1) A and D
- (2) A and B
- (3) A and C
- (4) C and D

Options 1. 1

2. 2

3. 3

4. 4

Question Type : **MSQ**

Question ID : **1879801480**

Option 1 ID : **1879805917**

Option 2 ID : **1879805918**

Option 3 ID : **1879805919**

Option 4 ID : **1879805920**

Status : **Not Answered**

Chosen Option : --

Q.58

Area of patch 1 is 2000 m² with a resource density of 5 units/m². Area of patch 2 is 3000 m² with a resource density of 10 units/m². As per the theory of ideal-free distribution, organisms distribute themselves such that the expected ratio of abundance of organisms in the two patches (patch 1: patch 2) is

- (1) 1:2
- (2) 2:3
- (3) 1:3
- (4) 3:2

Options 1. 1

2. 2

3. 3

4. 4

Question Type : **MSQ**

Question ID : **1879801530**

Option 1 ID : **1879806117**

Option 2 ID : **1879806118**

Option 3 ID : **1879806119**

Option 4 ID : **1879806120**

Status : **Not Answered**

Chosen Option : --

Q.59

Ribosomes prepared from a bacterium were fractionated by sucrose density gradient centrifugation (panel i) to separate the 30S, 50S and 70S populations. When the ribosome preparation was incubated individually with either elongation factor-G (EF-G), or a newly identified protein X, or GTP, the profile remained unchanged. Likewise, no changes were seen in the profile when the ribosomal preparation was incubated with EF-G + GTP or protein X + GTP. However, when the ribosomal preparation was incubated with protein X, EF-G and GTP together, it resulted in a change of profile which showed a decrease of the 70S peak area and increase in the peak areas for 30S and 50S (panel ii).

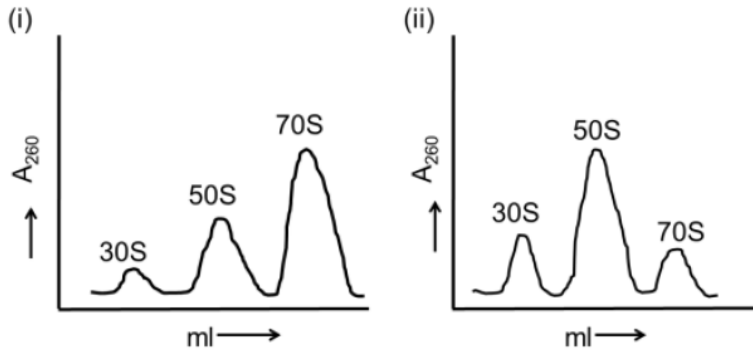

Choose the option that defines a correct conclusion from the observations.

- (1) Protein X is an anti-association factor which functions in the presence of EF-G and GTP
- (2) Protein X is a dissociation factor which functions in the presence of EF-G and GTP
- (3) Protein X binds GTP
- (4) EF-G is known to bind GTP, hence it can be concluded that the effect of GTP is through EF-G and protein X does not bind GTP.

- Options 1. 1
2. 2
3. 3
4. 4

Question Type : **MSQ**
 Question ID : **1879801486**
 Option 1 ID : **1879805941**
 Option 2 ID : **1879805942**
 Option 3 ID : **1879805943**
 Option 4 ID : **1879805944**
 Status : **Not Answered**
 Chosen Option : --

Q.60 The individuals considered in this question are having two haploid sets of autosomes and no Y-chromosome. The X:A ratio of the individuals, the type of organisms chosen, their primary sex and number of Barr bodies expected in their cells are shown in the table below:

X: A ratio	Organism	Primary Sex	Number of Barr bodies
i. 0.5	A. Human	I. Male	a. Zero
ii. 2	B. <i>Drosophila</i>	II. Female III. Metafemale	b. One c. Two d. Three

Select the option below with all correct matches:

- (1) i-A-II-a; ii-A-II-d; i-B-I-a; ii-B-III-a
- (2) i-A-I-a; ii-A-II-c; i-B-II-a; ii-B-I-a
- (3) i-A-II-c; ii-A-I-d; i-B-I-c; ii-B-II-b
- (4) i-A-II-a; ii-A-II-d; i-B-III-a; ii-B-I-a

- Options 1. 1
2. 2
3. 3
4. 4

Question Type : **MSQ**
Question ID : **1879801513**
Option 1 ID : **1879806049**
Option 2 ID : **1879806050**
Option 3 ID : **1879806051**
Option 4 ID : **1879806052**
Status : **Not Answered**
Chosen Option : --

- Q.61** Following statements were made about the events occurring during chick development.
- A. The fertilized chick egg undergoes discoidal meroblastic cleavage, however the cleavage does not extend into the yolky cytoplasm.
 - B. Development of primary hypoblast is mediated by localized migration of a group of highly specified and connected cluster of 30-40 cells.
 - C. By the stage XIII of chick embryogenesis and little prior to primitive streak formation, the formation of the hypoblast is just complete.
 - D. Hensen's node of the chick embryo signifies a region at the anterior end of the primitive streak with regional thickening of cells.
 - E. Inhibition of Wnt planar cell polarity pathway in the epiblast causes the mesoderm and endoderm to form centrally instead of peripherally.

Which one of the following combinations represents all correct statements?

- (1) A, B and D
- (2) A, C and E
- (3) A, B and C
- (4) A, C and D

Options 1. 1
2. 2
3. 3
4. 4

Question Type : **MSQ**
Question ID : **1879801497**
Option 1 ID : **1879805985**
Option 2 ID : **1879805986**
Option 3 ID : **1879805987**
Option 4 ID : **1879805988**
Status : **Not Answered**
Chosen Option : --

Q.62

During cell cycle, entry in the S-phase is tightly regulated. This is possible because:

- A. APC/C promotes ubiquitination of S-phase cyclins and mitotic cyclins, marking them for proteolyses at the mitotic exit.
- B. Cyclin B1 helps in the activation of S-phase CDKs only in late G1.
- C. As mitotic CDK activity declines in late mitosis, cdc14 phosphatase activates APC/C by dephosphorylating Cdh1, thus promoting formation of APC/C^{Cdh1}.
- D. Securin keeps S-phase cyclins in inactive state till late G1.

Which one of the options represents all correct statements?

- (1) A and B
- (2) A and C
- (3) B and C
- (4) B and D

- Options 1. 1
2. 2
3. 3
4. 4

Question Type : **MSQ**
 Question ID : **1879801478**
 Option 1 ID : **1879805909**
 Option 2 ID : **1879805910**
 Option 3 ID : **1879805911**
 Option 4 ID : **1879805912**
 Status : **Not Answered**
 Chosen Option : --

Q.63 Match the following plant diseases with the name of pathogen associated with the disease

Disease		Pathogen	
A	Powdery mildew	i	<i>Erwinia amylovora</i>
B	Rice blast	ii	<i>Pseudomonas syringae pv. syringae</i>
C	Bacterial canker	iii	<i>Magnaporthe oryzae</i>
D	Fire blight	iv	<i>Erysiphe cichoracearum</i>

- (1) A – ii; B – iii; C – i; D – iv
- (2) A – i; B – iv; C – ii; D – iii
- (3) A – iv; B – iii; C – ii; D – i
- (4) A – iii; B – ii; C – iv; D – i

- Options 1. 1
2. 2
3. 3
4. 4

Question Type : **MSQ**
 Question ID : **1879801522**
 Option 1 ID : **1879806085**
 Option 2 ID : **1879806086**
 Option 3 ID : **1879806087**
 Option 4 ID : **1879806088**
 Status : **Not Answered**

Q.64 The anterior-posterior compartment of each segment of *Drosophila* is defined by *wingless* and *engrailed* genes. The following statements are given towards explaining their regulation:

- A. Wingless is a secretory factor
- B. Engrailed is a secretory factor and forms a long-range concentration gradient
- C. Engrailed regulates Wingless through Hedgehog which forms a short-range concentration gradient
- D. β -catenin homologue is the signalling molecule upstream of Engrailed, which gets cleaved by GSK3 homologue
- E. Cubitus interruptus is an intracellular signalling molecule in the Engrailed expressing cells.

Which one of the following options has all the correct statements towards the regulation of anterior-posterior compartment of segments?

- (1) B only
- (2) C only
- (3) B and E
- (4) A, C and D

Options 1. 1

2. 2

3. 3

4. 4

Question Type : **MSQ**

Question ID : **1879801494**

Option 1 ID : **1879805973**

Option 2 ID : **1879805974**

Option 3 ID : **1879805975**

Option 4 ID : **1879805976**

Status : **Not Answered**

Chosen Option : --

Q.65

Given below are certain adaptations which are seen in various groups of animals:

- A. Ovipary
- B. Streamlined body
- C. Pouch for carrying eggs
- D. Porous egg shell
- E. Breast bone as large keel
- F. Webbed feet
- G. Laterally compressed coccygeal bone
- H. Unidirectional pulmonary system to provide large quantities of oxygen
- I. Barbules or hooklets on the vanes of each feather

Which combination of the above adaptations facilitate bird flight?

- (1) B, E, H, I
- (2) A, B, C, G
- (3) D, F, G, I
- (4) B, D, E, F

Options 1. 1

2. 2

3. 3

4. 4

Question Type : **MSQ**

Question ID : **1879801520**

Option 1 ID : **1879806077**

Option 2 ID : **1879806078**

Option 3 ID : **1879806079**

Option 4 ID : **1879806080**

Status : **Not Answered**

Chosen Option : --

Q.66 The following observations are made on a 30-residue polypeptide

- (a) Unordered structure is observed in water but a helical conformation is observed in medium of low dielectric constant.
- (b) The peptide is resistant to degradation by proteases.
- (c) Red blood cells are lysed by the peptide.
- (d) β -mercaptoethanol has no effect on peptide structure.

Which of the following statements can be correctly attributed to the above observations?

- (1) The peptide is entirely composed of D-amino acids and is amphipathic.
- (2) The peptide is entirely composed of L-amino acids and is not amphipathic.
- (3) The peptide is rich in disulphide bonds between D-cysteines.
- (4) The peptide is entirely composed of L-aromatic amino acids.

Options 1. 1

2. 2

3. 3
4. 4<https://pathfinderacademy.in/>

Question Type : **MSQ**
 Question ID : **1879801474**
 Option 1 ID : **1879805893**
 Option 2 ID : **1879805894**
 Option 3 ID : **1879805895**
 Option 4 ID : **1879805896**
 Status : **Not Answered**
 Chosen Option : --

Q.67 Acetylcholine is a potent neurotransmitter, which is released from the neurons. After release they diffuse across the synaptic cleft and combine with nicotinic acetylcholine receptor molecules in the membrane of the postsynaptic cell. The interaction of acetylcholine with the nicotinic acetylcholine receptor produces large transient increase in the permeability of the membrane to specialized ions resulting in signal transduction for nerve impulse. Acetylcholine receptor is a

- (1) ligand-gated cation channel
- (2) ligand-gated anion channel
- (3) voltage-gated cation channel
- (4) voltage-gated anion channel

Options 1. 1
2. 2
3. 3
4. 4

Question Type : **MSQ**
 Question ID : **1879801492**
 Option 1 ID : **1879805965**
 Option 2 ID : **1879805966**
 Option 3 ID : **1879805967**
 Option 4 ID : **1879805968**
 Status : **Not Answered**
 Chosen Option : --

Q.68 A disease-resistant plant was crossed with a susceptible plant and the resultant F_1 plants were disease resistant. The F_1 plant was selfed and the F_2 individuals were analyzed for qualitative and quantitative disease resistance. The following statements were hypothesized

- A. Qualitative resistance follows Mendelian ratio.
- B. In the F_2 individuals demonstrating qualitative resistance, "resistance" is dominant
- C. Quantitative resistance is always monogenic
- D. Qualitative resistance can be polygenic

Which one of the following combination of statements is correct?

- (1) A, C and D
- (2) A, B and C
- (3) A, B and D
- (4) B, C and D

Options 1. 1
2. 2
3. 3
4. 4

<https://pathfinderacademy.in/>

Question Type : **MSQ**
Question ID : **1879801504**
Option 1 ID : **1879806013**
Option 2 ID : **1879806014**
Option 3 ID : **1879806015**
Option 4 ID : **1879806016**
Status : **Not Answered**
Chosen Option : --

Q.69 Certain plant species produce cyanogenic glycosides to protect them from pathogens. A researcher has identified a variant of such a plant that has higher level of cyanogenic glycoside yet it is highly susceptible to a specific fungal pathogen. To interpret this counter-intuitive observation, the researcher hypothesizes that the fungal pathogen has higher level of

- A. β -glucosidase activity
- B. formamide hydrolyase activity
- C. cytochrome P-450 enzyme
- D. cyanide-resistant, alternative oxidase activity

Which one of the following combinations of the above hypotheses is correct?

- (1) A and B
- (2) B and C
- (3) C and D
- (4) B and D

Options 1. 1

2. 2

3. 3

4. 4

Question Type : **MSQ**
Question ID : **1879801502**
Option 1 ID : **1879806005**
Option 2 ID : **1879806006**
Option 3 ID : **1879806007**
Option 4 ID : **1879806008**
Status : **Not Answered**
Chosen Option : --

Q.70

Match the geological time period with the extinction or diversification events associated with them:

Geological time	Event
A. Cenozoic	i. Angiosperm diversification
B. Cretaceous	ii. Modern fauna diversification (bivalves, gastropods, bryozoans, malacostracan crustaceans)
C. Paleozoic	iii. Megafauna extinction
D. Quaternary	iv. Mammal diversification

- (1) A – ii, B - i, C – iii, D - iv
- (2) A – iv, B - i, C – ii, D - iii
- (3) A – ii, B - iii, C – i, D - iv
- (4) A – iv, B - iii, C – i, D - iv

- Options 1. 1
 2. 2
 3. 3
 4. 4

Question Type : **MSQ**
 Question ID : **1879801531**
 Option 1 ID : **1879806121**
 Option 2 ID : **1879806122**
 Option 3 ID : **1879806123**
 Option 4 ID : **1879806124**
 Status : **Not Answered**
 Chosen Option : --

Q.71

Condition	Abundance	Predators learn	Resource overlap
A	Mimic > Model	Yes	Yes
B	Model > Mimic	Yes	No
C	Mimic = Model	No	Yes
D	Model ≥ Mimic	No	No

Which among the above sets of conditions are best suited for mimicry to be successful?

- (1) Condition A
- (2) Condition B
- (3) Condition C
- (4) Condition D

- Options 1. 1
 2. 2
 3. 3
 4. 4

Question Type : **MSQ**
 Question ID : **1879801527**
<https://pathfinderacademy.in/>

Option 1 ID : <https://pathfinderacademy.in/>
Option 2 ID : **1879806106**
Option 3 ID : **1879806107**
Option 4 ID : **1879806108**
Status : **Not Answered**
Chosen Option : --

Q.72 Aldosterone increases the reabsorption of Na^+ from the tubular fluid in the thick ascending limb of loop of Henle and in the distal tubule. These effects are explained in the following proposed statements:

- A. Aldosterone increases the number of $\text{Na}^+\text{-Cl}^-$ symporter in the apical membrane of principal cells in the early portion of distal tubule
- B. The number of Na^+ channels (ENaC) is increased in the apical membrane of principal cells in the late portion of distal tubule by aldosterone
- C. The synthesis of Na^+ , $\text{K}^+\text{-ATPase}$ in the basolateral portion of principal cells in distal tubule is decreased by the action of aldosterone
- D. Aldosterone increases the reabsorption of Na^+ across the apical cell membrane in the thick ascending limb of loop of Henle by decreasing Na^+ , $\text{K}^+\text{-ATPase}$ in it

Which one of the following combinations represents both correct statements?

- (1) A and B
- (2) B and C
- (3) C and D
- (4) A and D

Options 1. 1

2. 2

3. 3

4. 4

Question Type : **MSQ**
Question ID : **1879801508**
Option 1 ID : **1879806029**
Option 2 ID : **1879806030**
Option 3 ID : **1879806031**
Option 4 ID : **1879806032**
Status : **Not Answered**
Chosen Option : --

Q.73

In the nervous system, the action potential is generated at the axon hillock in physiological conditions and it is conducted to the terminal end of axon. The location specific origin of action potential and its direction-specific conduction are explained by a researcher in the following proposed statements:

- A. The membrane of axon hillock has highest threshold for the generation of action potential
- B. The membrane of axon hillock contains large numbers of voltage-gated Na^+ channels and that makes it more excitable
- C. The propagating action potential in the middle of the axon cannot generate another action potential in the direction of cell body since a large fraction of voltage-gated Na^+ channels in the preceding portion is voltage inactivated
- D. As the number of voltage-gated Na^+ channels is less in the preceding portion of axonal membrane, the propagating action potential in the middle of the axon cannot generate another action potential in the direction of cell body.

Which one of the following combinations represents both correct explanations?

- (1) A and B
- (2) B and C
- (3) C and D
- (4) A and D

Options 1. 1

- 2. 2
- 3. 3
- 4. 4

Question Type : **MSQ**

Question ID : **1879801507**

Option 1 ID : **1879806025**

Option 2 ID : **1879806026**

Option 3 ID : **1879806027**

Option 4 ID : **1879806028**

Status : **Not Answered**

Chosen Option : --

Q.74 Strain A mice were crossed with strain B mice and first generation F_1 mice were obtained, i.e. $(A \times B)F_1$. A scientist then implanted thymectomized and irradiated $(A \times B)F_1$ mice with a B-type thymus and then reconstituted the animal's immune system with an intravenous infusion of $(A \times B)F_1$ bone marrow cells. The chimeric mice were infected with lymphocytic choriomeningitis virus (LCMV) and the spleen T cells were then tested for their ability to kill LCMV-infected target cells from the strain A or strain B mice.

Which one of the following is the correct outcome of the experiment?

- (1) LCMV-infected target cells from strain A only will be killed
- (2) LCMV-infected target cells from strain B only will be killed
- (3) LCMV-infected target cells from both strain A and B will be killed
- (4) Neither cells from strain A nor from strain B will be killed

Options 1. 1

- 2. 2
- 3. 3
- 4. 4

Question Type : **MSQ**

Question ID : **1879801493**

Option 1 ID : **1879805969**

Option 2 ID : **1879805970**

Option 3 ID : <https://pathfinderacademy.in/>
 Option 4 ID : 1879805972
 Status : Not Answered
 Chosen Option : --

Q.75 The table below shows photosynthetic type, temperature and sunlight intensity levels.

Photosynthetic Type	Temperature	Sunlight Intensity
A. C ₃ Plant	i High	P. High
B. C ₄ plant	ii Moderate	Q. Moderate
	iii Low	R. Low

Which of the following correctly matches the plant photosynthetic type with the temperature and sunlight conditions in which photosynthetic rate per unit leaf area is maximum for that plant?

- (1) A – i – P; B – iii – R
 (2) A – iii – P; B – i – Q
 (3) A – i – R; B – ii – Q
 (4) A – ii – Q; B – i – P

Options 1. 1
 2. 2
 3. 3
 4. 4

Question Type : **MSQ**
 Question ID : 1879801524
 Option 1 ID : 1879806093
 Option 2 ID : 1879806094
 Option 3 ID : 1879806095
 Option 4 ID : 1879806096
 Status : Not Answered
 Chosen Option : --

CSIR-NET Life Sciences Practice Books Combo Set



<https://www.amazon.in/Pathfinder-Academy-CSIR-JRF-NET-Sciences-Practice/dp/9380473060/>



<https://www.flipkart.com/pathfinder-academy-csir-jrf-net-life-sciences-practice-books-combo-set/p/itmegqwdh6zfs8xp?pid=9789380473062>

